

TECHNICAL INFORMATION

CITIZEN QUARTZ

Cal. No. 0610



 **CITIZEN**

CITIZEN IS A REGISTERED TRADEMARK OF CITIZEN WATCH CO., JAPAN.

Contents

§1. OUTLINE	1
§2. SPECIFICATIONS	1
§3. HANDLING THE WATCH	2
A. Name of Parts.....	2
B. Setting the Time	2
C. Setting the Date.....	3
D. Using the Chronograph	3
E. Adjusting the Position of the Chronograph Hands (After Replacing the Battery)	5
§4. ARRANGEMENT OF WHEELS ON DIAL SIDE	6
§5. DISASSEMBLY AND ASSEMBLY OF MOVEMENT	7
§6. TROUBLESHOOTING AND ADJUSTMENT	10

§1. OUTLINE

This model is an analog quartz watch having a chronograph function to measure time up to 59 minutes, 59 seconds, 99 by 1/100 second.

§2. SPECIFICATIONS

Caliber NO.		0610A
Type		Analog Quartz watch
Movement size (mm)		ø30.8 × 4.1t
Accuracy (At normal temperature)		±20 sec/month (+5°C ~ +35°C/41°F ~95°F)
IC		1 unit of C/MOS-LSI
Operating temperature		-10°C~+60°C (14°F~140°F)
Converter		Bipolar step motor, 3 units
Time adjustment		Impossible
Measurement gate		10 sec.
Additional functions		<ul style="list-style-type: none">• Date (With quick setting mechanism)• Chronograph Measurement unit: 1/100 sec. Max. measurement indication: 59min. 59sec, 99/100sec.
Battery	Part No. (Code)	280-44 (SR-927W)
	Nominal Voltage (Capacity)	1.55V (60mAH)
	Life time	Approx. 2 years

§3. HANDLING THE WATCH

A. Name of Parts

<Models with the crown at the 3:00 position>

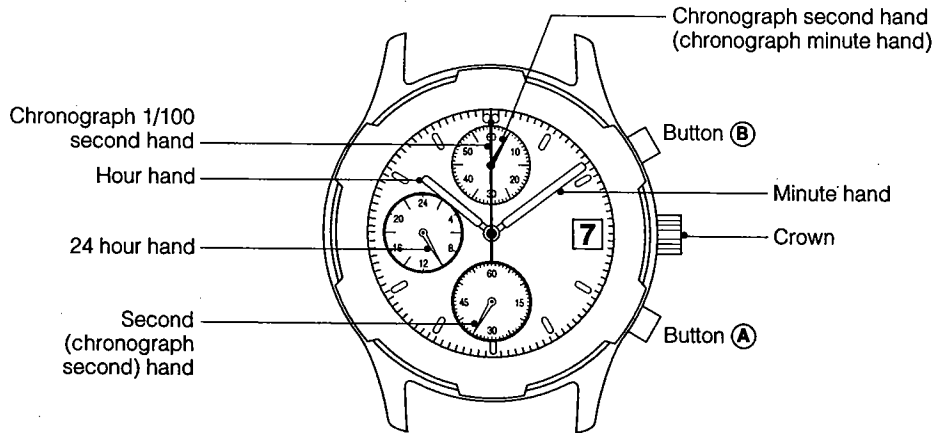

<Models with the crown at the 9:00 position>

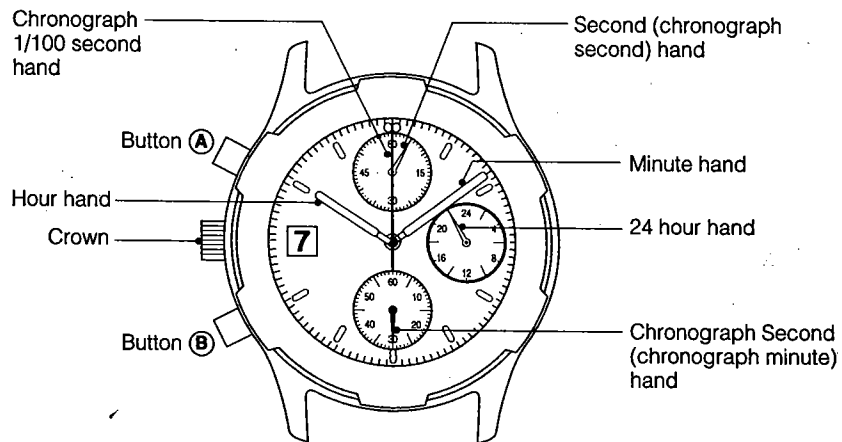

B. Setting the Time

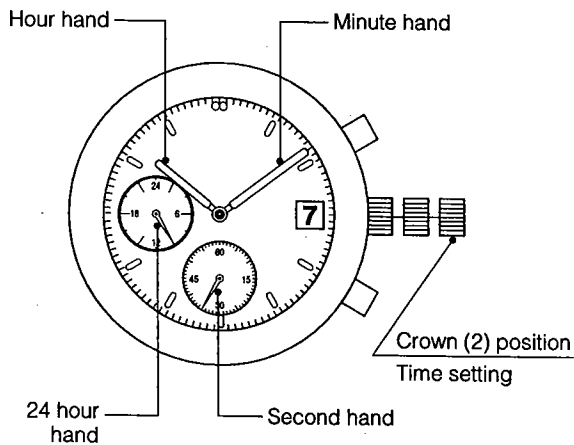

1. Pull the crown out to the (2) position, and the second hand moves to the "0" position fast, then stops there.
2. Set the 24 hour, hour and minute hands to the present time by turning the crown. Time setting synchronizes the minute hand → hour hand → 24 hour hand.
3. After setting the time, push the crown to the normal position (0) and the watch will start at the correct time.

C. Setting the Date

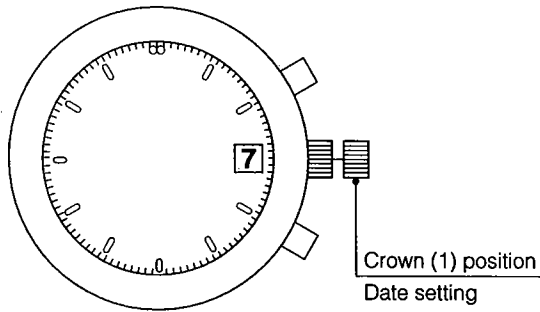

1. Pull the crown out to the (1) position.
2. Set the date to the desired date by turning the crown.
 - Do not set the date between 9:00pm and 1:00am. It may affect the calendar function and you may not get the correct date the next day.
3. After setting the date, be sure to firmly return the crown to its normal position.

D. Using the chronograph

The chronograph can measure up to 60 minutes in 1/100 second increments.

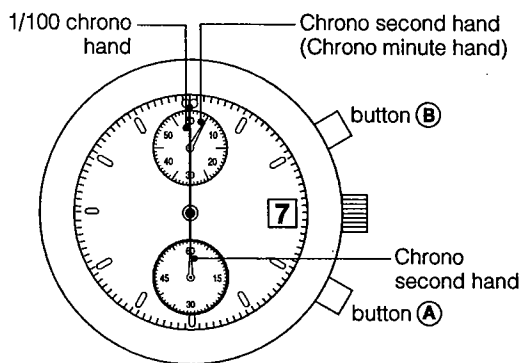

<The chronograph 1/100 second hand>

- Although the 1/100 second hand stop at the "0" position when the measured time is over 61 seconds, the watch will continue to measure the elapsing time. After 61 seconds it changes to demonstration operation, making one revolution per minute.

To start the chronograph measurement

- Press button (B) to start the chronograph measurement. The second hand will become the chrono second hand, and will advance to the "0" position. At that moment the chronograph measurement starts.

When 61 seconds have passed after the chronograph has been started:

- The chronograph second hand will become the chronograph minute hand.

To stop the chronograph measurement

- Press button **(B)** to stop the chronograph measurement.

When the measured time is less than 61 seconds.

The chronograph minute, second and 1/100 second hands will stop at the measured time.

When the measured time is over 61 seconds.

1. The chronograph minute and second hands will stop at the measured time.
The chronograph 1/100 second hand will stop at the "0" position. Now read the minutes and seconds from the chronograph.
2. Press button **(B)** again to advance the chronograph 1/100 second hand to the measured time.
Now read the 1/100 seconds from the chronograph.

To reset the chronograph

Press button **(A)** to reset the chronograph.

The chronograph second hand will return to its function as the second hand for present time.

The other chronograph hands will return to the "0" position.

<Standard measurement>

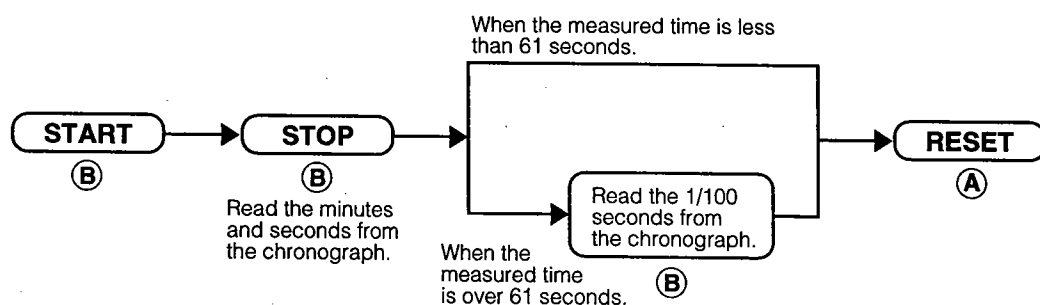

<Accumulated elapsed time measurement>

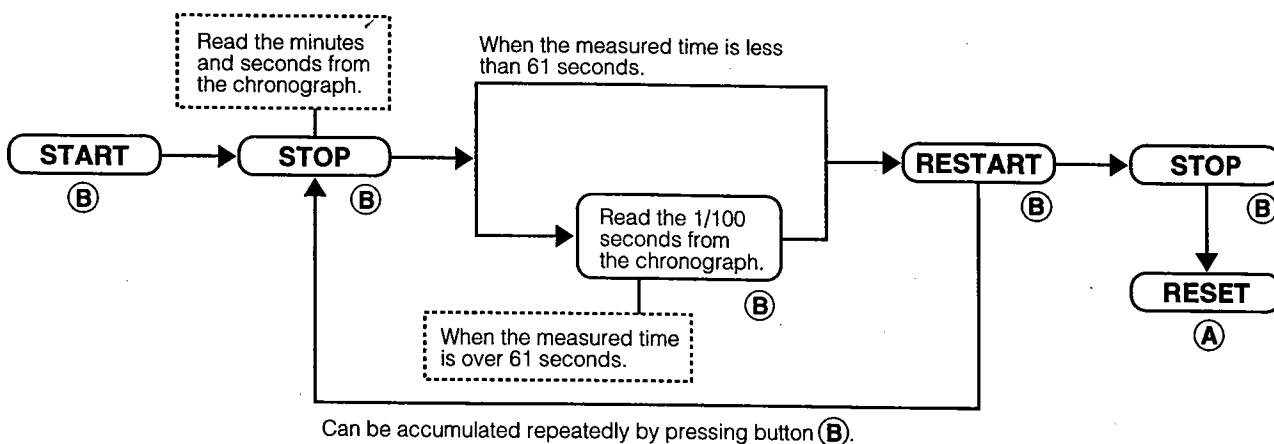

E. Adjusting the Position of the Chronograph Hands (After Replacing the Battery)

After replacing the battery or if the chronograph hands do not return to the "0" position when the chronograph is reset.

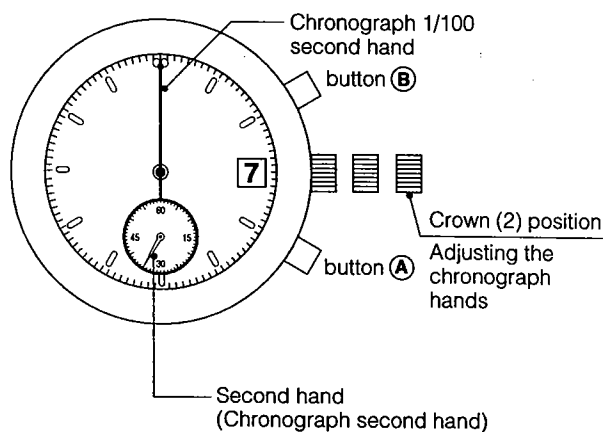

1. Pull the crown out to position (2).
2. Press button (B) or (A) to set the chronograph hands to the "0" position.
Button (B): Set the chronograph 1/100 second hand to the "0" position.
Button (A): Set the chronograph second hand to the "0" position.
* The chronograph hands can be advanced rapidly by continuously pressing button (A) or (B).
3. Once the chronograph hands have been set to the "0" position, reset the time to the correct time. Once the time has been set, return the crown to the "0" position.
4. Press button (A) again to check that each of the hands of the chronograph are reset to the "0" position.

§4. ARRANGEMENT OF WHEELS ON DIAL SIDE

CAL NO. 0610

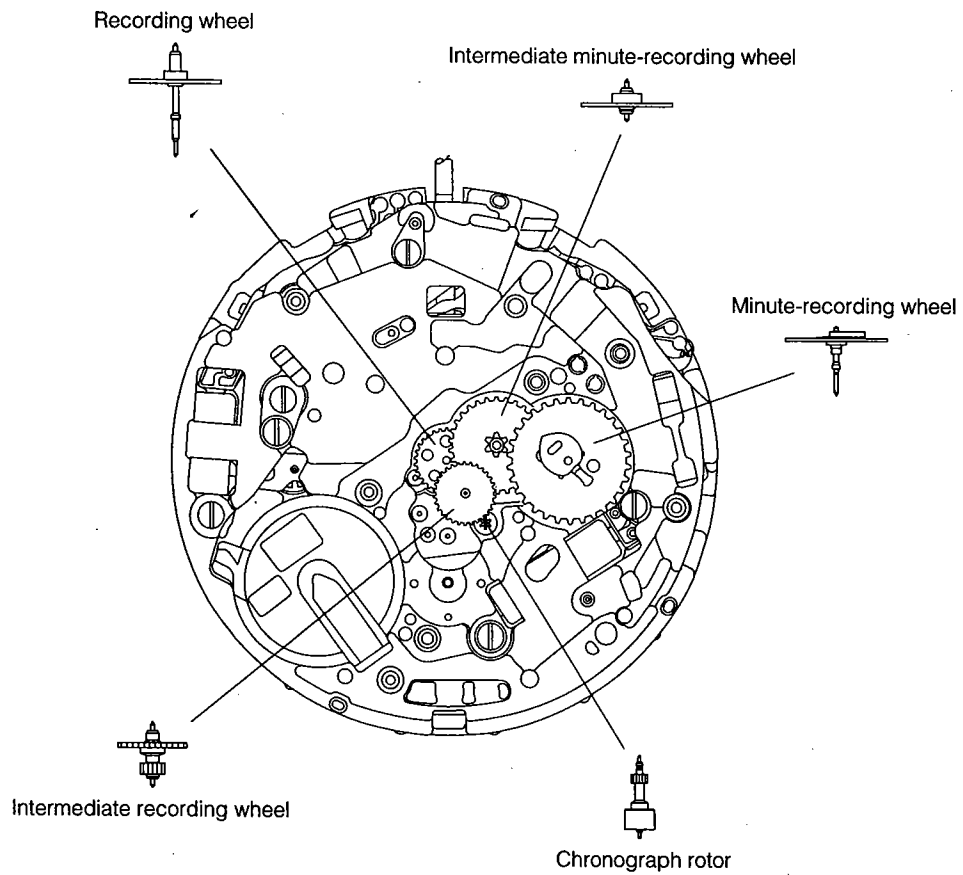
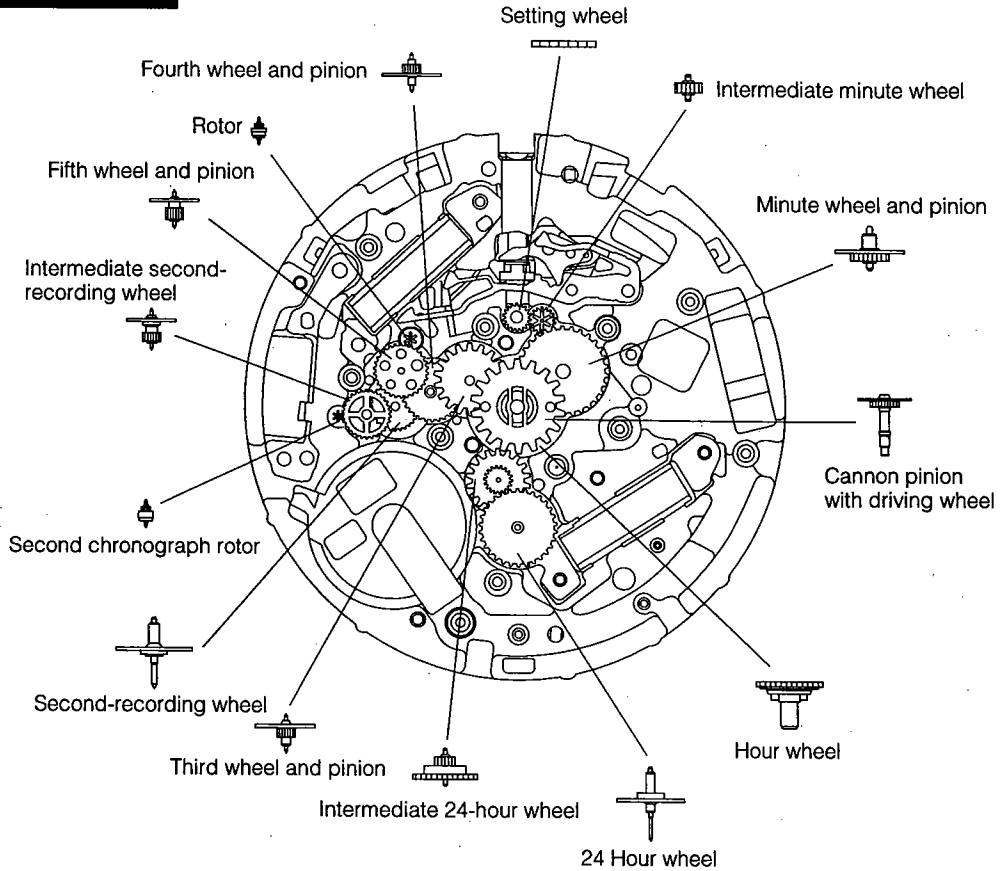

§5. DISASSEMBLY AND ASSEMBLY OF THE MOVEMENT

Disassembly procedure: ① → ④⑨

Assembly procedure: ④⑨ → ①

● Lubrication mark

- Ⓐ : A-Lube oil
- Ⓥ : V-Lube oil
- Ⓕ : F-Lube oil
- Ⓞ : CH-1 oil

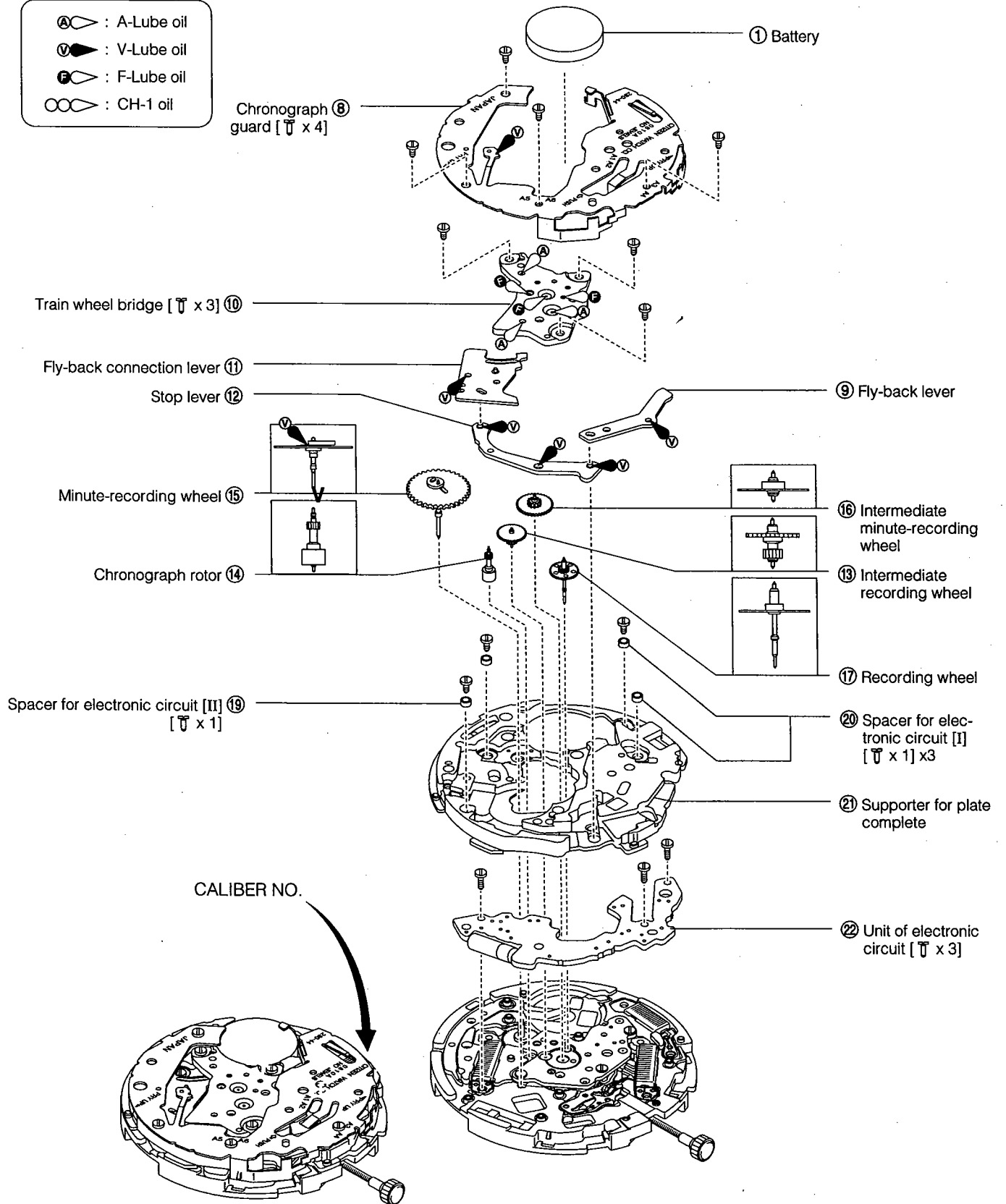

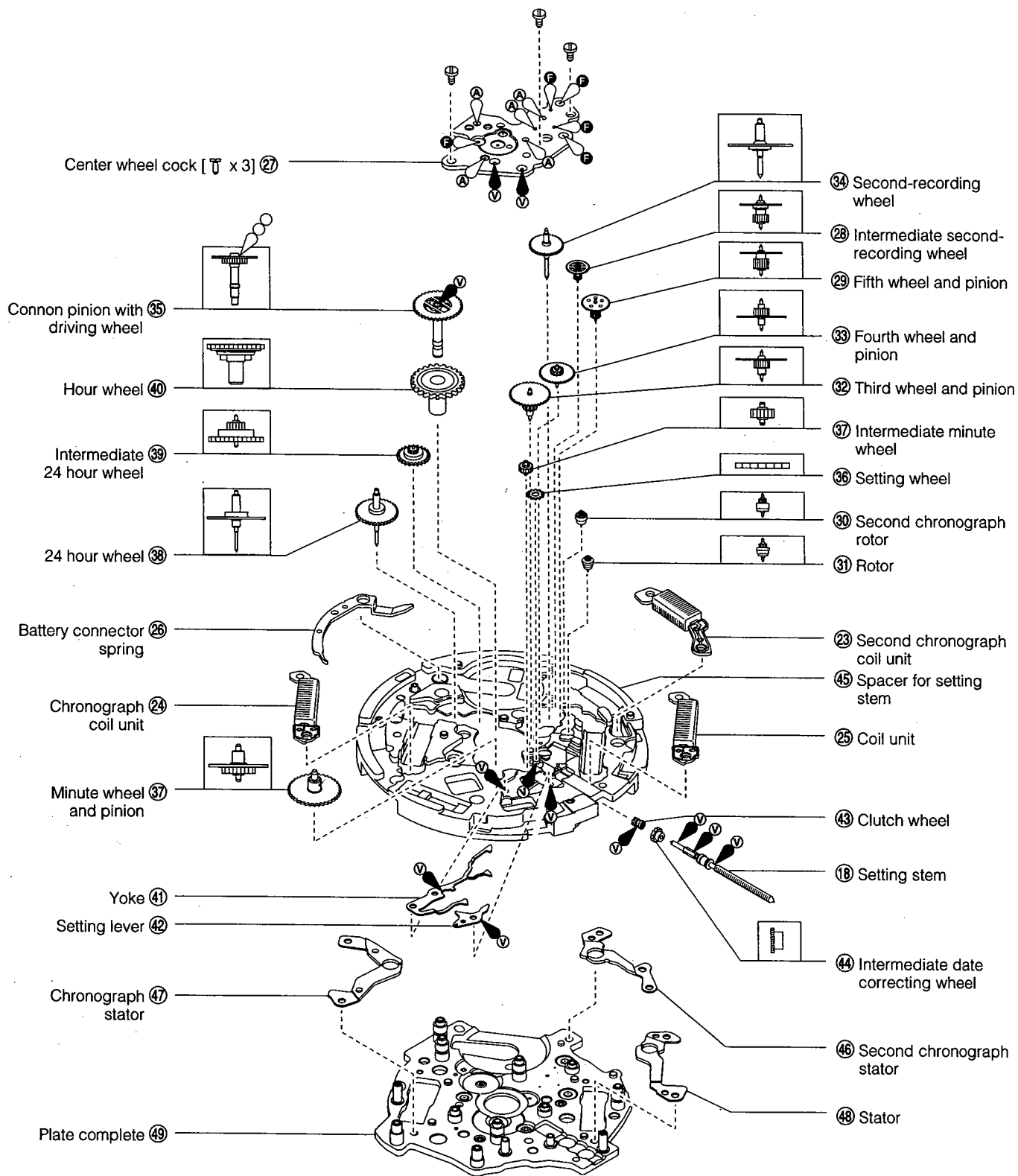

* Use the movement holder No. 05 for disassembly and assembly.

Date dial guard [T x 3] ②

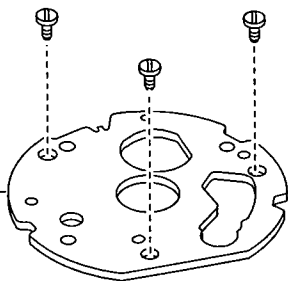

Date dial ③

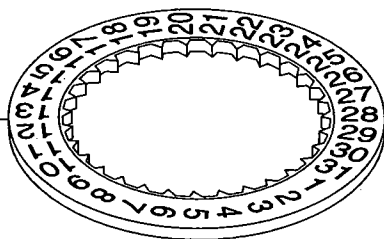

Date dial driving wheel ⑤



Date jumper ④



⑥ Calendar corrector lever



⑦ Date dial guard supporter

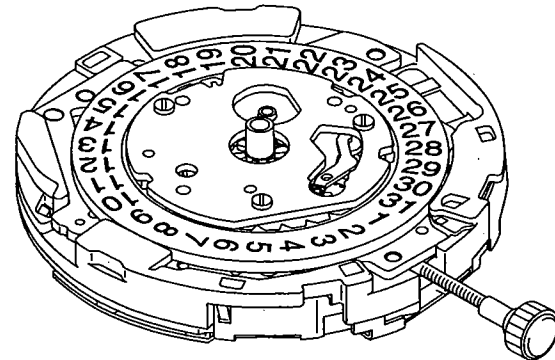
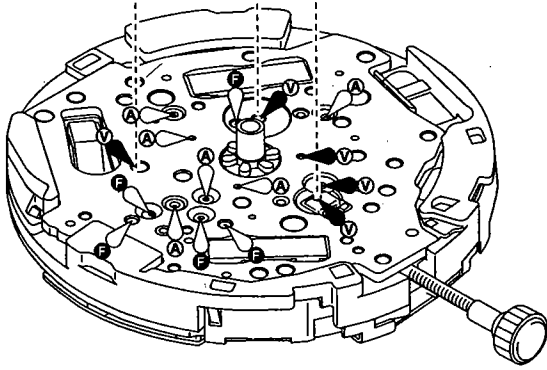
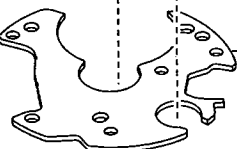

\$6. TROUBLESHOOTING AND ADJUSTMENT

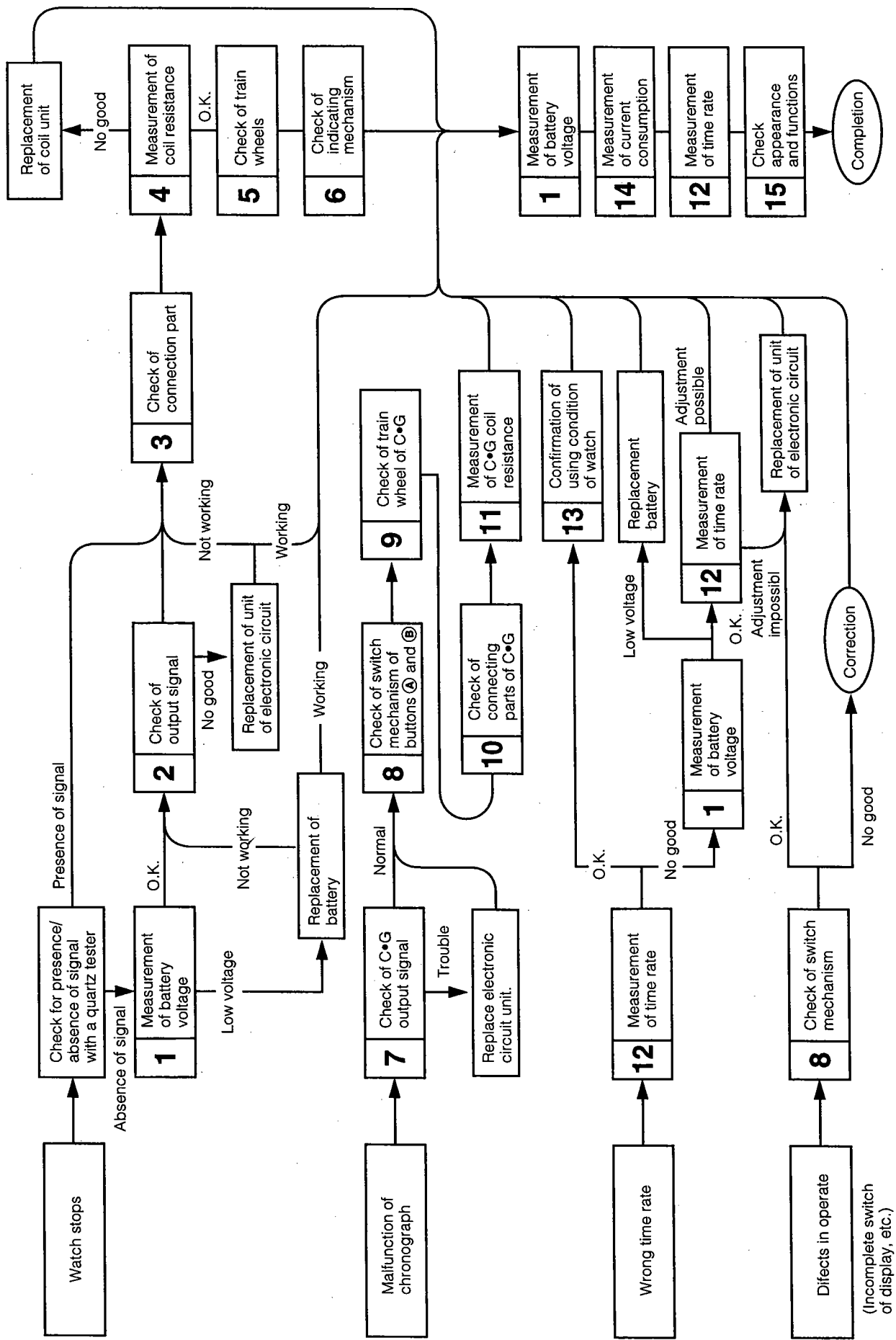

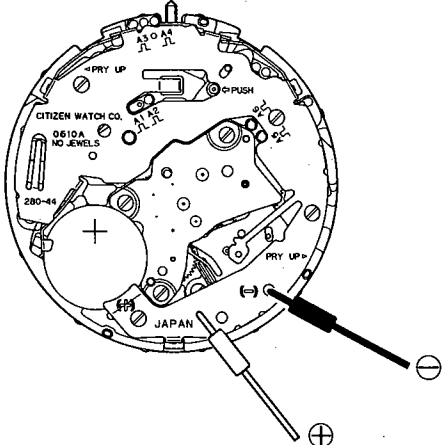
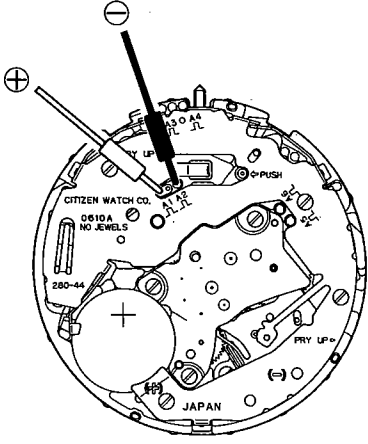
Check Items	Method	Results and repair procedure
<p>① Measurement of battery voltage</p>	<p>* Refer to Technical Manual, Basic Course II-1-a for the setting procedure of the tester</p> <p style="text-align: center;"><Tester range: DC. 3V></p> 	<ul style="list-style-type: none"> • Over 1.5V → Non-defective • Under 1.5V → Replace the battery
<p>② Check of output signal</p>	<p>* Refer to Technical Manual, Basic Course: II-1-b for the setting procedure of the tester.</p>  <p>This watch outputs the following signals.</p> <ul style="list-style-type: none"> • Output signals (A1 μL , A2 μL) of the time system (Minute, and hour) • Output signals (A3 μL , A4 μL) of the chronograph system (1/100 second, minute) • Output signals (A5 μL , A6 μL) of the second (Time and chronograph system) <p>If the watch stops, check the output signals A1 μL , A2 μL and A5 μL , A6 μL among the above signals.</p> <p>* Confirm that the crown is at the normal position (0 stage).</p>	<p>Output signals</p> <ul style="list-style-type: none"> • Tester pointer moves to right and left from 0V every 1 sec. → Normal. • Tester pointer does not moves → Replace electronic circuit unit

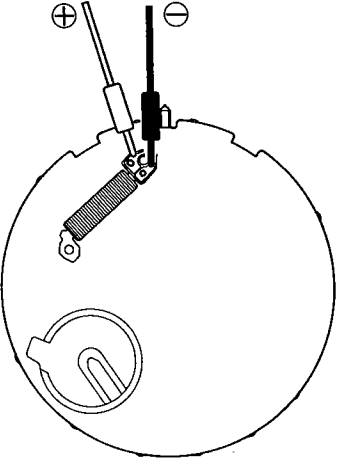
Check Items	Method	Results and repair procedure
<p>③ Check of connection part</p>	<p>* Refer to the analog part of Technical Manual, Basic Course: II-2-a.</p>	
<p>④ Measurement of coil resistance</p>	<p>* Refer to Technical Manual, Basic Course: II-1-c for the setting procedure of the tester.</p> <p><Tester range: R x 10Ω></p> 	<p>1) Measurement of coil unit</p> <ul style="list-style-type: none"> • 1.9 kΩ~2.3 kΩ → Non-defective • Out of 1.9 kΩ~2.3 kΩ → Replace of coil unit
<p>⑤ Check of train wheels</p>	<p>* Refer to Technical Manual, Basic Course: II-2-b.</p>	
<p>⑥ Check of indicating mechanism</p>	<p>* Check the hour wheel, minute wheel and pinion, and second wheel and pinion.</p>	

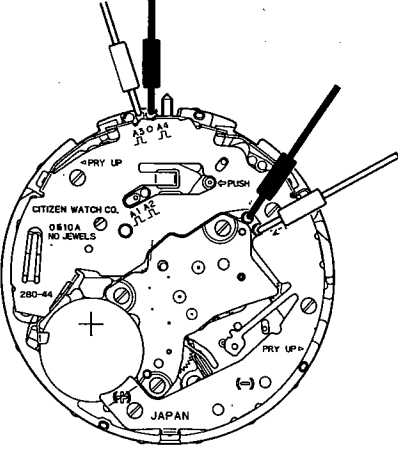
Check Items	Method	Results and repair procedure
<p>⑦ Check of CG output signals</p>	<p>* For the setting method of the tester, refer to Technical Manual, Basic Course II-1-b.</p> <p style="text-align: right;"><Tester range: DC 0.3V></p> <p>① Check the output signal (A3 JL, A4 JL) of the chronograph system (Minute, 1/100 second).</p> <p>② Check the output signal (A5 JL, A6 JL) of the chronograph system. (second)</p> <p><Measuring method> Check the output signal in the quick setting mode of each chronograph hand.</p> <p>(1) Pull the crown out to the second click.</p> <p>(2) Set the tester.</p> <p>(3) With the tester lead pins applied, press and hold the (A) button or (B) button.</p> <p style="margin-left: 20px;">(A) button: Chronograph second hand setting (A3 JL, A4 JL)</p> <p style="margin-left: 20px;">(B) button: Chronograph 1/100 second hand setting (A5 JL, A6 JL)</p> <p>(4) Check the movement of the tester pointer.</p> <div style="text-align: center;">  </div>	<ul style="list-style-type: none"> • Tester pointer swings → Normal. • Tester pointer does not swing. → Check connections. <p style="text-align: center;">↓</p> <p>Connections are normal. → Replace the electronic circuit unit.</p>
<p>⑧ Check of switch mechanism of buttons (A) and (B)</p>	<p>1) Confirm that the buttons (A) and (B) operate smoothly and check the switch springs of (A) and (B) for deformation.</p> <p>2) Check the part between the switch springs and pattern of the electronic circuit unit of dirt and dust.</p> <p>3) Confirm that the fly-back connection lever, stop lever, and fly-back lever are installed normally.</p>	<p>1) Buttons do not move smoothly.</p> <ul style="list-style-type: none"> • Dust or dirt → Clean. • Supply oil to push button packings again. • Deformation → Replace parts. <p>2) Dust or dirt → Clean</p>

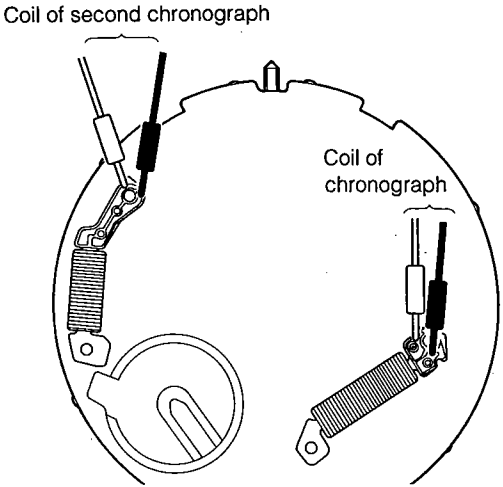
Check Items	Method	Results and repair procedure
<p>⑨ Check of train wheel of chronograph</p>	<p>* Refer to Technical Manual, Basic Course: II-2-b.</p>	
<p>⑩ Check of connecting part of chronograph</p>	<p>* Refer to Technical Manual, Basic Course: II-1-a.</p>	
<p>⑪ Measurement of coil resistance of chronograph</p>	<p>* Refer to Technical Manual, Basic Course: II-1-c for the setting procedure of the tester.</p> 	<p>Coil of chronograph</p> <ul style="list-style-type: none"> • 1.9kΩ ~ 2.2 kΩ → Normal • Out of 1.9 kΩ ~ 2.2 kΩ → Replace coil of chronograph <p>Coil of second chronograph</p> <ul style="list-style-type: none"> • 2.0 kΩ ~ 2.5 kΩ → Normal • Out of 2.0 kΩ ~ 2.5 kΩ → Replace coil of second chronograph.
<p>⑫ Measurement/adjustment of time rate</p>	<p>* Refer to Technical Manual, Basic Course: II-2-d.</p>	
<p>⑬ Confirmation of using condition of watch</p>	<p>* Refer to Technical Manual, Basic Course: II-2-e.</p>	

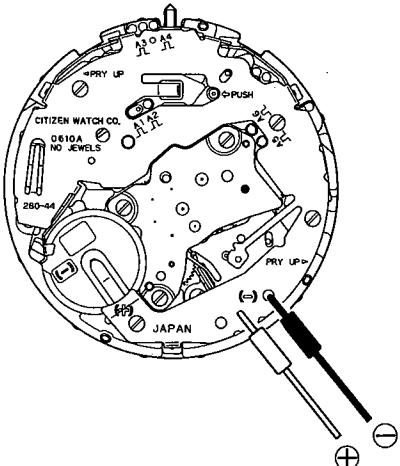
Check Items	Method	Results and repair procedure
<p>14 Measurement of current consumption</p>	<p>* For the setting method of the tester, refer to Technical Manual, Basic Course II-1-f.</p> <p>1. Measurement in normal time indication mode</p>  <p>2. Measurement in chronograph mode</p> <p>* Apply the tester similarly to the measurement in 1 above.</p> <p>(1) Set the tester. (Tester range: 1mA)</p> <p>(2) Press the switch corresponding to the B button to start the chronograph (start the second hand).</p> <p>(3) Keep the chronograph operation for 60 seconds (until the 1/100-second hand stops).</p> <p>(4) Return the tester range to 10μA. After the tester pointer is stabilized, read the current consumption.</p> <p>* While the 1/100-second hand is moving, the current consumption cannot be measured accurately since it is high and unstable. While the 1/100-second hand is moving, the current consumption is about 0.2mA.</p> <p>3. Measurement on electric circuit unit</p> <p>* Set the tester similarly to the measurement in 1 above.</p>	<p>1. Normal time indication</p> <ul style="list-style-type: none"> • Under 2.7μA → Normal • Over 2.7μA → Measurement on electronic circuit unit <p>2. In chronograph mode</p> <ul style="list-style-type: none"> • Under 3.4μA → Normal • Over 3.4μA → Measurement on electric circuit unit <p>3. Measurement on electric circuit unit</p> <ul style="list-style-type: none"> • Under 0.3μA → Check of train wheels. • Over 0.3μA → Check the electric circuit unit.
<p>15 Check of appearance and functions</p>	<p>* Refer to Technical Manual, Basic Course II-2-f.</p>	