

SEIKO

QUARTZ

Cal. 2320A

PARTS LIST

Cal. 2320A



131 810



221 810



225 810



231 810



241 810



261 810



271 810



281 810



282 810



☆354 811



383 810



384 810



386 810



391 810



491 810



4001 810



4002 810



4146 810



4216 810



4219 810



4239 810



4242 810



4270 810



☆Toshiba W1V



022 110



022 424



022 740

2/1

Cal. 2320A

Characteristics

Casing diameter: 15.1 × 13.0 mm
 Maximum height: 2.5 mm without battery
 Jewels: 8j
 Frequency of quartz crystal oscillator: 32,768 Hz (Hz=Hertz cycle per second)
 Driving system: Step motor system (2 poles)
 Regulation system: Rotary step switch type

PART NO.	PART NAME	PART NO.	PART NAME
131 810	Third wheel bridge	☆Toshiba W1V } ☆Maxell SR620SW }	Silver oxide battery
221 810	Center wheel & pinion		
☆225 810 } ☆225 811 }	Cannon pinion		
231 810	Third wheel & pinion		
241 810	Fourth wheel & pinion		
261 810	Minute wheel		
☆271 810 } ☆271 811 }	Hour wheel		
281 810	Setting wheel		
282 810	Clutch wheel		
☆354 810 } ☆354 811 }	Winding stem		
383 810	Setting lever		
384 810	Yoke (Clutch lever)		
386 810	Setting lever spring		
391 810	Second setting lever		
491 810	Dial washer		
4001 810	Circuit block		
4002 810	Coil block		
4146 810	Step rotor		
4216 810	Insulator for battery connection A		
4219 810	Insulator for battery connection B		
4239 810	Rotor stator		
4242 810	Plus terminal of battery connection		
4270 810	Battery connection		
011 547	Upper hole jewel for third wheel		
011 547	Upper hole jewel for fourth wheel		
011 547	Upper hole jewel for fifth wheel		
011 547	Lower hole jewel for fifth wheel		
011 550	Lower hole jewel for third wheel		
011 550	Lower hole jewel for fourth wheel		
011 551	Upper hole jewel for center wheel		
011 726	Lower hole jewel for center wheel		
022 110	Dial screw		
022 424	Third wheel bridge screw		
022 424	Circuit block screw		
022 424	Coil block screw		
022 740	Setting lever spring screw		
023 345	Tube for yoke		
027 823	Minute wheel pin		
027 827	Second setting lever adjusting pin		
027 828	Guide pin for setting lever spring		
027 833	Pin for unlocking stem		
027 834	Setting lever pin		



☆⇒Please see remarks.

Part numbers in light letters are not shown in photos.

Cal. 2320A

Remarks:

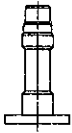
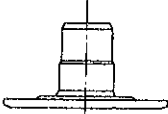
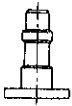
Cannon pinion, Hour wheel Combination

Type	Cannon pinion	Hour wheel
a (Dials with index jewels)	 225 811	 271 811
b (Dials other than the above)	 225 810	 271 810

Winding stem.....There are two types of winding stem. Select a suitable one by referring to the design of the case.

☆354 810.....The gasket is fixed to the winding stem.

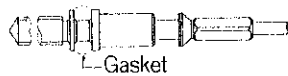

☆354 811.....The gasket is fixed to the crown.

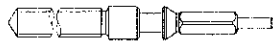

If the combination of the winding stem and case is unknown, check the case number and refer to "SEIKO Quartz Casing Parts List" to choose a corresponding winding stem.

Battery.....The applied battery for this calibre might be added the substitutive in the future.
In that case, please refer to separate "BATTERIES FOR SEIKO QUARTZ WATCHES".

TECHNICAL GUIDE

SEIKO
QUARTZ

CAL.2320A

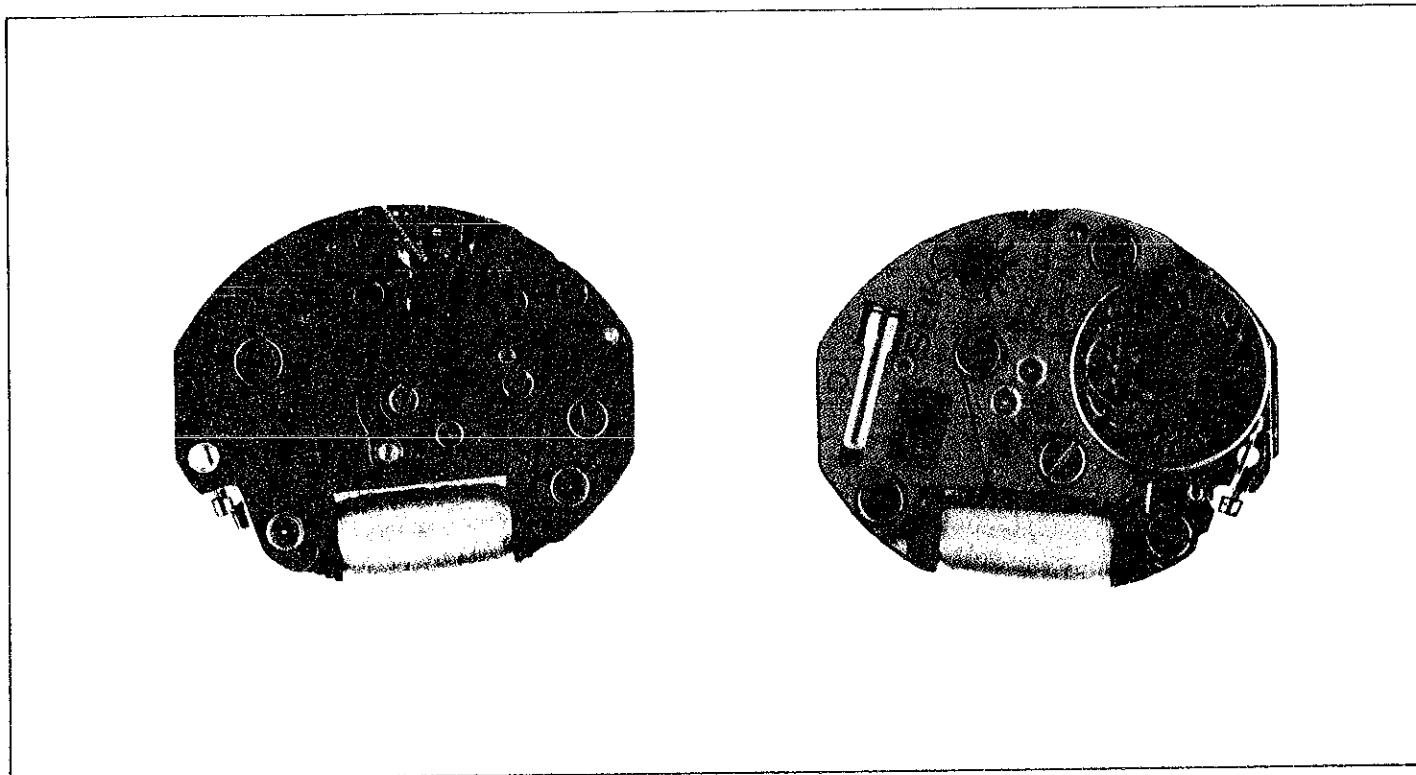

CONTENTS

I. SPECIFICATIONS AND FEATURES	1
1. Specifications	1
2. Features	1
3. Time accuracy adjusting	2
II. DISASSEMBLING, REASSEMBLING AND LUBRICATING	3
1. Remarks for disassembling and reassembling of the case	4
2. Disassembling, reassembling and lubricating of the minute hand ~ hour wheel	4
3. Disassembling, reassembling and lubricating of the circuit block, coil block and gear train mechanism	5
4. Disassembling, reassembling and lubricating of the setting mechanism	7
III. CHECKING AND ADJUSTMENT	8
1. Guide table for checking and adjustment	8
2. Procedures for checking and adjustment	9
A : Check output signal	9
B : Check battery voltage	9
• How to check battery electrolyte leakage and repair	9
C : Check battery conductivity	11
D : Check circuit block conductivity	11
E : Check circuit block output terminal conductivity	11
F : Check coil block	13
G : Check output signal	13
H : Check second setting condition	13
I : Check reset condition	15
J : Check gear train	15
K : Check accuracy	15
L : Measuring current consumption	17

I. SPECIFICATIONS AND FEATURES

1. Specifications

Item	Cal. No.	2320A
Time indication		2-hand time indication (hour & minute)
Additional mechanism		Electronic circuit reset switch
Crystal oscillator		32,768 Hz (Hz=Hertz Cycle per second)
Loss/gain		Loss/gain at normal temperature range Monthly rate : less than ± 15 seconds (Annual rate : less than ± 3 minutes)
Casing diameter		15.1mm x 13.0mm
Height		2.5mm without battery
Operational temperature range		$-10^{\circ}\text{C} \sim +60^{\circ}\text{C}$ ($14^{\circ}\text{F} \sim 140^{\circ}\text{F}$)
Driving system		Step motor system (2 poles: steps once every 20 seconds)
Regulation system		Rotary step switch system
Battery power		Silver oxide battery Toshiba W1V or Maxell SR620SW Battery life is approximately 3 years. Voltage: 1.55V
Jewel		8 jewels

2. Features

Cal. 2320A is a thin and compact 2-hand crystal oscillator ladies' watch incorporating the 3-year life battery and the movement with the height of 2.5mm without battery, specially designed for use as a dress watch.

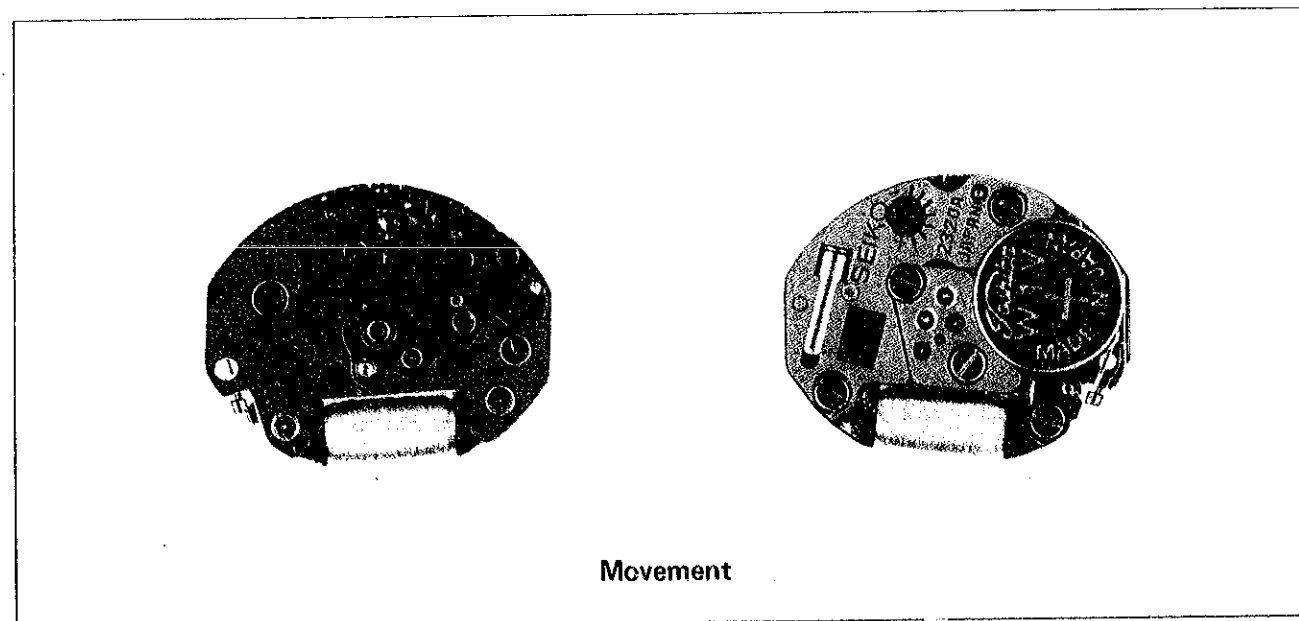

3. Time accuracy adjusting

For time adjustment a new rotary step switch system is employed in Cal. 2320A different from the conventional trimmer condenser system. As the different time adjustment is necessary, adjust time according to the following procedures.

Time adjustment procedures:

- 1 First check time accuracy with the Quartz Tester. Be sure to set the measuring time selection switch at "10" or "0.01". Measurement is impossible if the selection switch is set at other measuring times than "10" or "0.01".
- 2 Next turn the rotary step switch and adjust.
 - Every 1-step turn of the rotary step switch will make a change of about 0.7 seconds fast or slow per day (gaining by turning clockwise and losing by turning counterclockwise).
 - Adjust the rotary step switch at a step nearest "0" in loss or gain per day.
- 3 After having turned the rotary step switch, be sure to check time accuracy with the Quartz Tester.

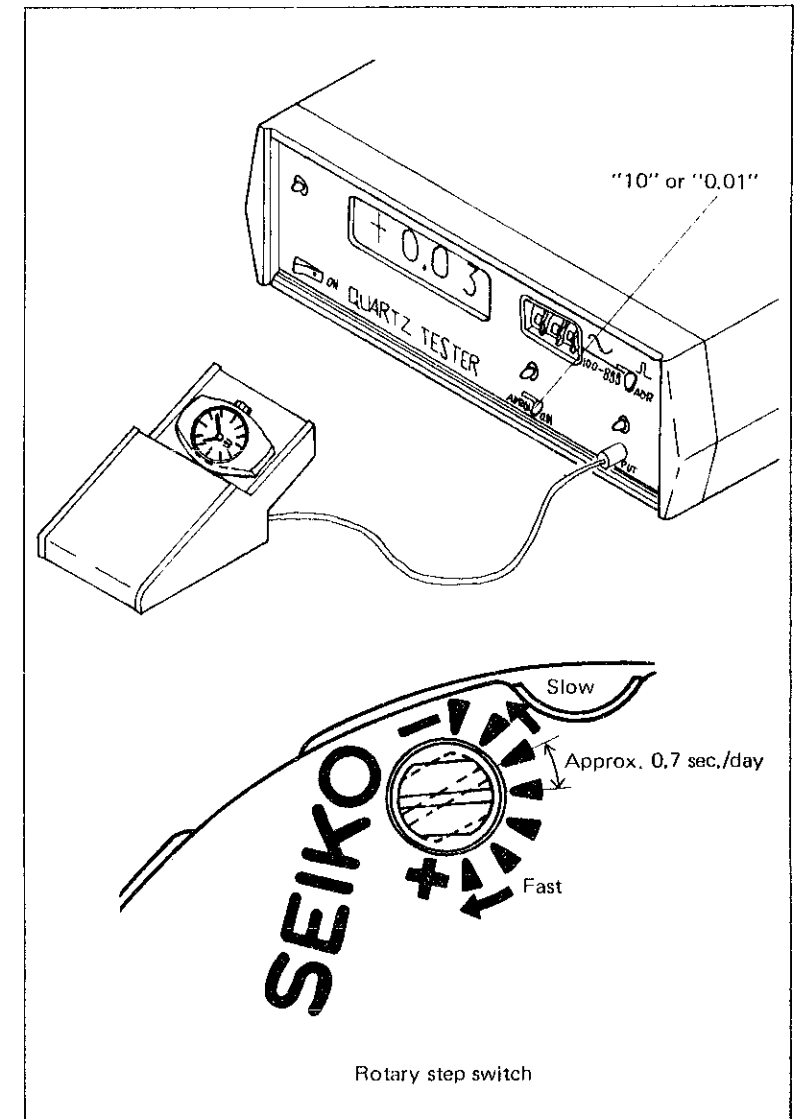

When turning the rotary step switch, fit the center line of the groove to the ◀ mark. If the center line of the groove is not in line with the ◀ mark, time accuracy may change excessively.

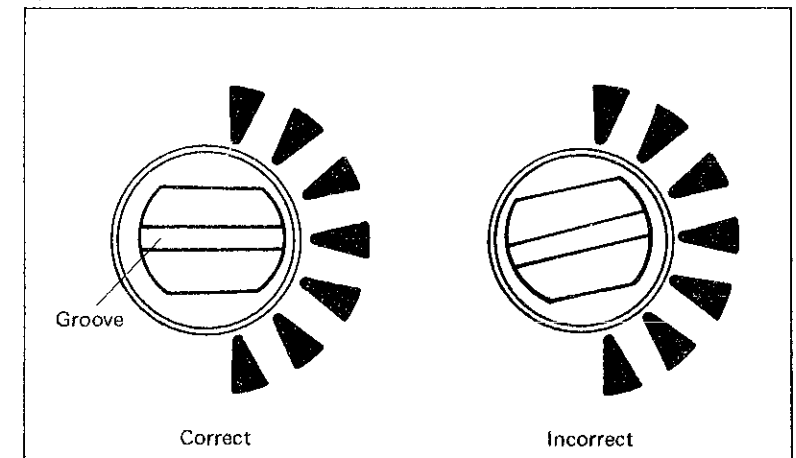

II. DISASSEMBLING, REASSEMBLING AND LUBRICATING





● Disassembling and reassembling

Disassembling procedures Figs. : ① ~ ③⑩

Reassembling procedures Figs. : ③⑩ ~ ①

● Lubricating

The following marks in the diagrams for disassembling and reassembling indicate the types of oil, oil quantity to be applied and the lubricating portions. Be sure to lubricate according to the marks.



Types of oil		Oil quantity	
	Moebius A		Liberal quantity
	SEIKO Watch Oil S-6		Normal quantity
Never lubricate the portions marked ⊗			Extremely small quantity

● After-sale servicing instruments and materials

Use the movement holder S-664 commonly used for Cal. 16 when disassembling and reassembling.

● List of screws used

The following three types of screws are used in Cal. 2320A.

Shape	Parts No.	Name (common)	Shape	Parts No.	Name (common)
	022 110	Dial screw (2 pcs.)		022 424	Third wheel bridge screw (2 pcs.)
	022 740	Setting lever spring screw (3 pcs.)			Circuit block screw (2 pcs.)
					Coil block screw (1 pc.)

● Remarks for disassembling and reassembling

Cal. 2320A is a thin and compact watch. Therefore check for dust, lint or other contamination to prevent the watch from stopping.

1. Remarks for disassembling and reassembling of the case

- The case ring is classified into the following two types according to the shapes of the grooves for the stem with crown. Be careful not to mistake the upper side for the lower side.

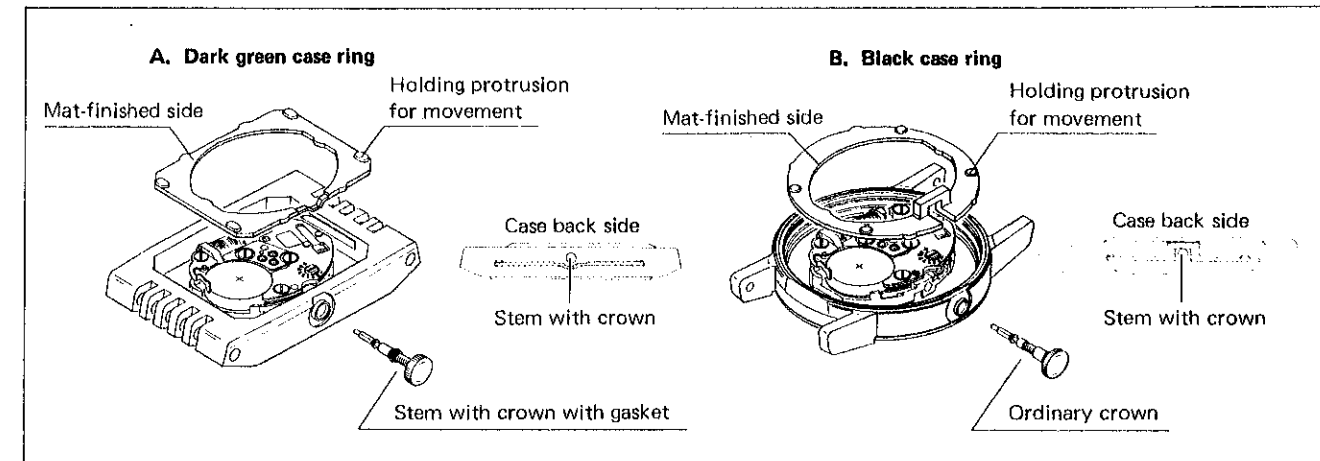

2. Disassembling, reassembling and lubricating of the minute hand ~ hour wheel

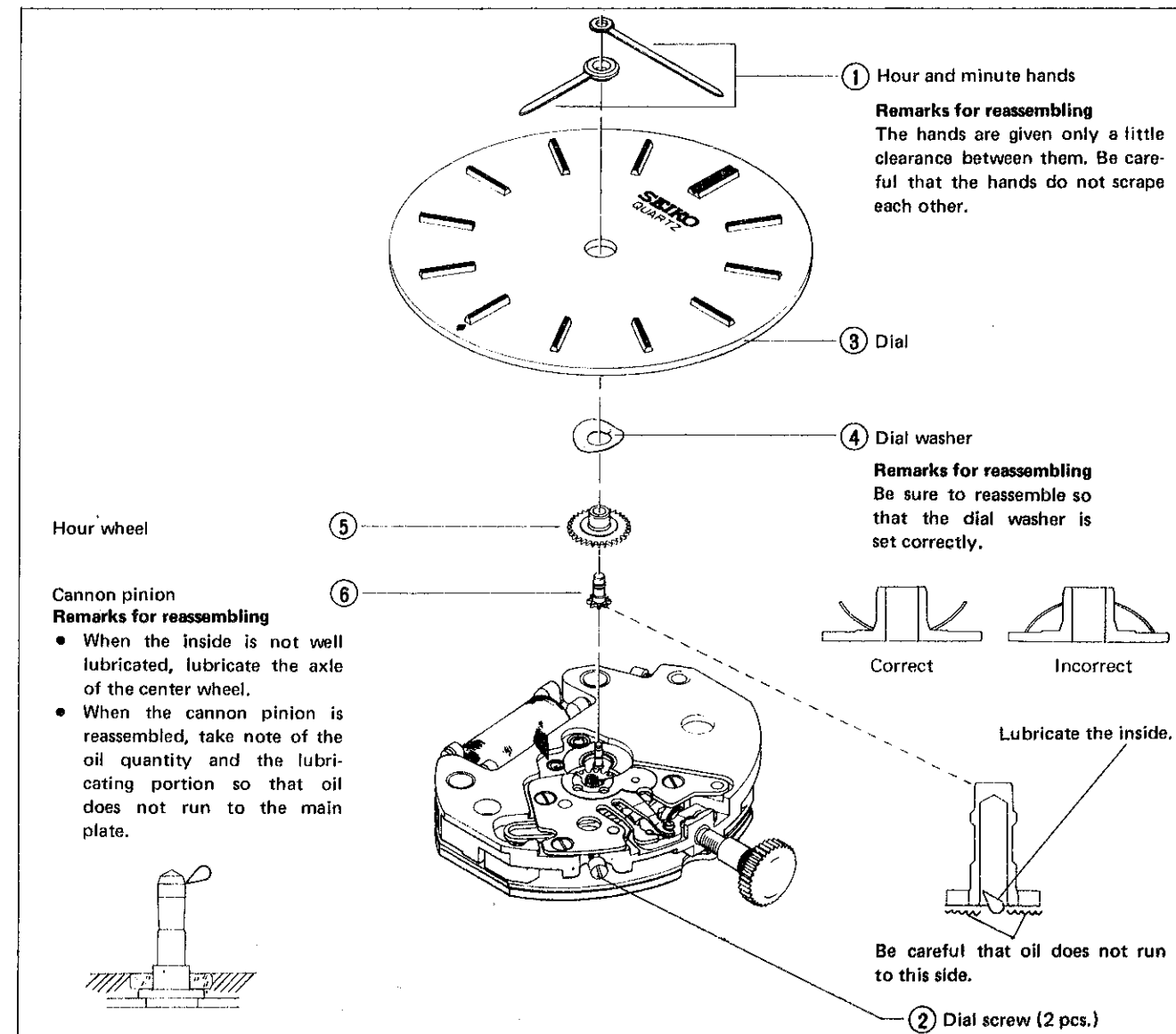

3. Disassembling, reassembling and lubricating of the circuit block, coil block and gear train mechanism

Remarks for disassembling and reassembling of the gear train

- Be sure to disassemble and reassemble the gear train with the crown at the pushed in position (in order to avoid damaging parts through the interference between the second setting lever and the gear).
- The gear train mechanism, except for the step rotor and the lower hole jewel for center wheel may not be lubricated. When lubricating, lubricate it to an extent that it gets wet.

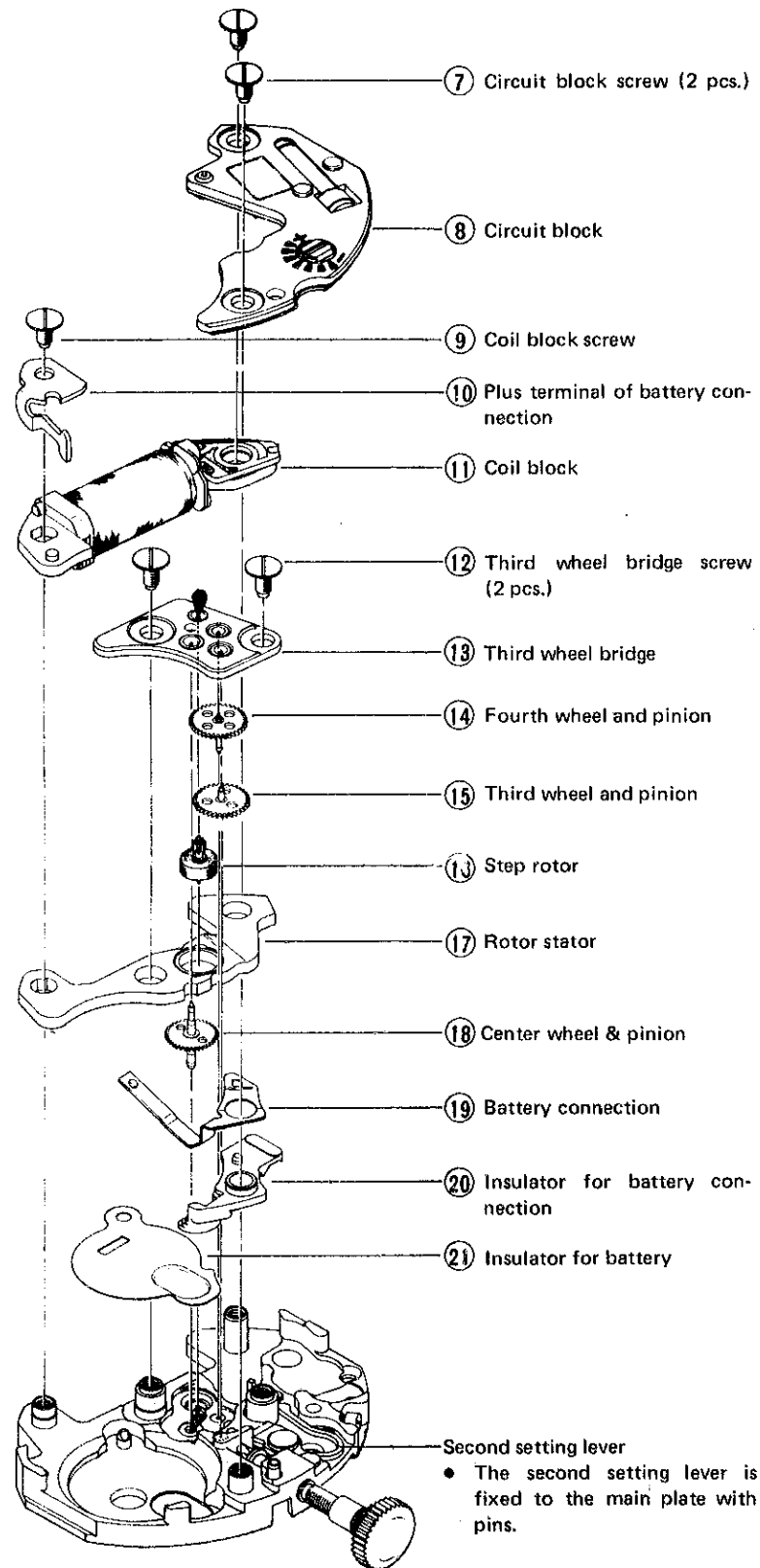

Remarks for disassembling and reassembling

⑧ Circuit block

Remarks for disassembling and reassembling

- Be careful not to cut the copper leaf patterns of the circuit block with tweezers, etc.
- Be careful not to deform the terminal of the rotary step switch.
- Do not touch each element.

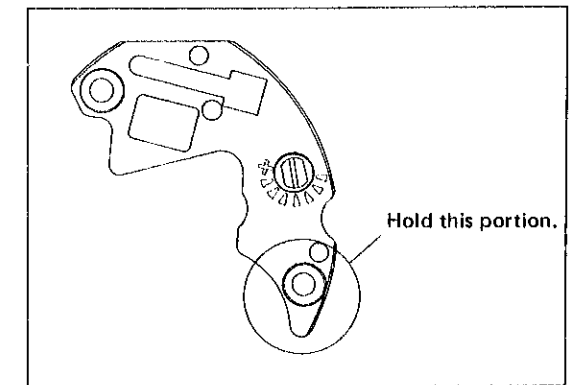

⑪ Coil block

Remarks for disassembling and reassembling

- Handle the coil block as shown in the illustration below so as not to scratch the coil wire and the lead terminal. And be careful not to deform it.

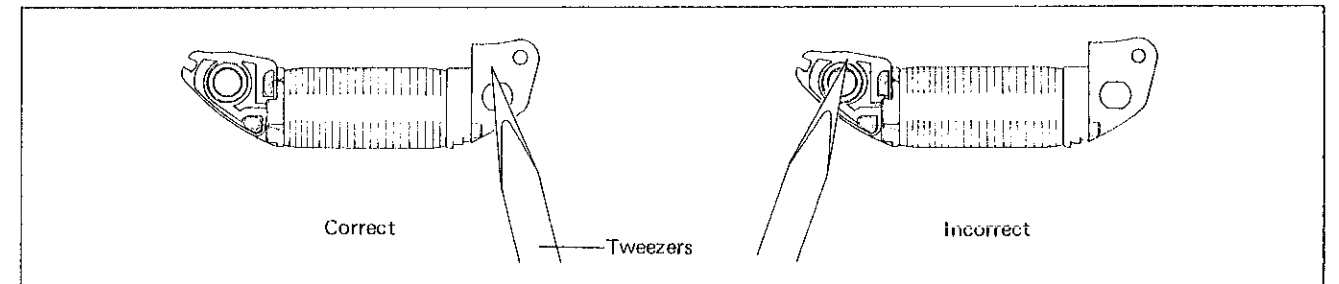

⑯ Step rotor

Remarks for reassembling

- Check for the clearances of the upper and lower pivots for the step rotor after reassembling the coil block screw ⑨.

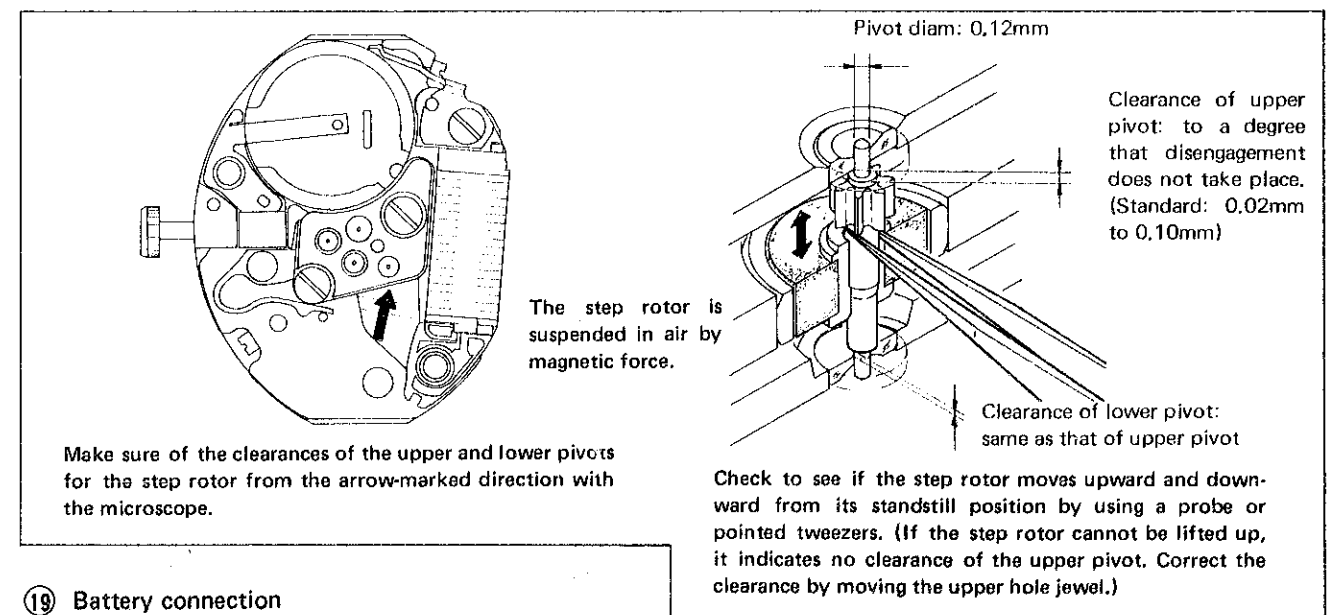

⑲ Battery connection

⑳ Insulator for battery connection

㉑ Insulator for battery

Remarks for disassembling

The above mentioned 3 parts are not required to be disassembled except when the parts are replaced and cleaned.

4. Disassembling, reassembling and lubricating of the setting mechanism

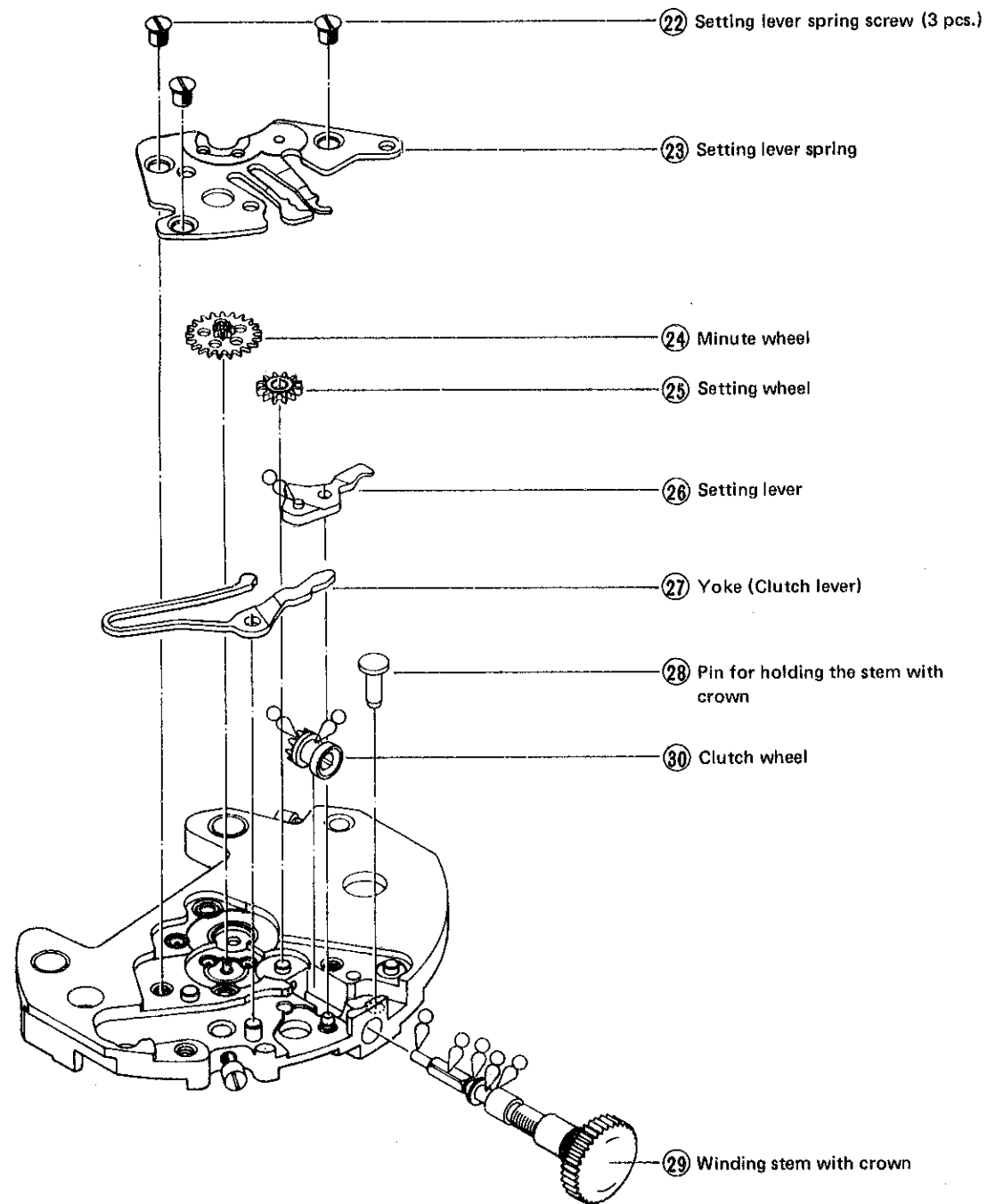





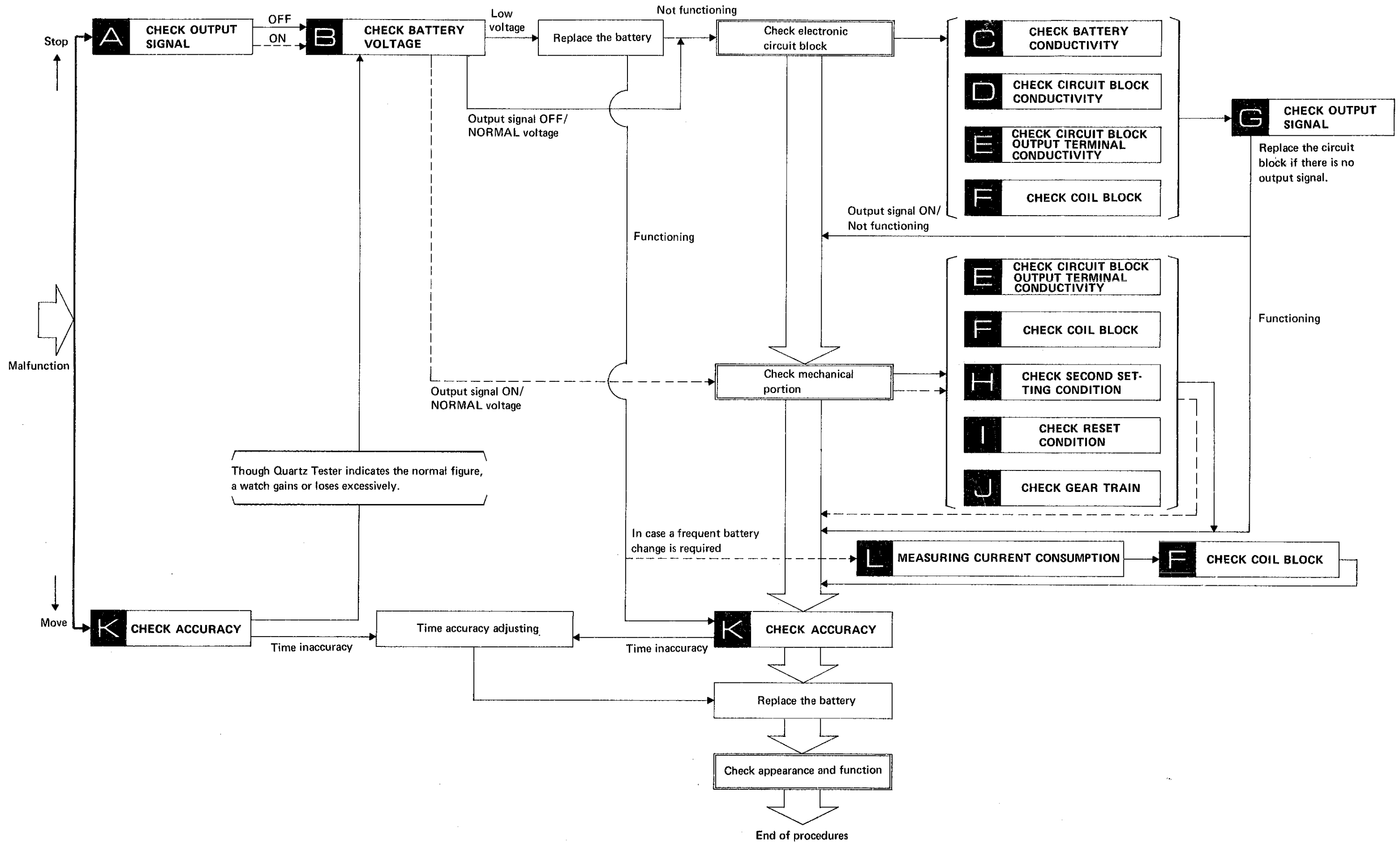

III. CHECKING AND ADJUSTMENT

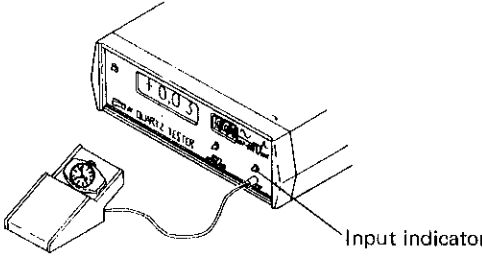
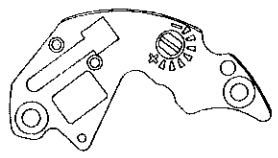
1. Guide table for checking and adjustment

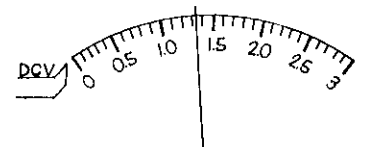

2. Procedures for checking and adjustment

	Procedures
CHECK OUTPUT SIGNAL	<p>Check output signal.</p> <p>1. Set up the Quartz Tester.</p> <div style="border: 1px solid black; padding: 5px; margin: 5px 0;"> <p>Note: Be sure to set the measuring time selection switch at "10" or "0.01".</p> </div> <p>2. Checking Check for blinking input indication light. The blinking intervals are 5 seconds and 10 seconds.</p> <div style="border: 1px solid black; padding: 5px; margin: 5px 0;"> <p>Note:</p> <ul style="list-style-type: none"> • Check output signal with the crown pushed in to the normal position. • When using QT-200, connect the earth terminal with the release terminal. </div> 
CHECK BATTERY VOLTAGE	<p>Check battery voltage.</p> <div style="border: 1px solid black; padding: 5px; margin: 5px 0;"> <p>When there is battery electrolyte leakage, refer to "HOW TO CHECK BATTERY ELECTROLYTE LEAKAGE AND REPAIR" below for repairing.</p> </div>
HOW TO CHECK BATTERY ELECTROLYTE LEAKAGE AND REPAIR	<p>Procedures:</p> <ol style="list-style-type: none"> Remove the movement from the case. Disassemble the movement. Wipe off battery electrolyte on the circuit block. <ol style="list-style-type: none"> Wipe off battery electrolyte with a cloth moistened with distilled water. (If distilled water is not available, use tap water.) Wipe off with a cloth moistened with alcohol. (If the cleaned portions remain wet with water, they will corrode with rust.) Dry with hot air by using a dryer. 

Results	Adjustment and repair
<p>Blinking — Normal</p> <p>No blinking — Defective</p>	<p>Proceed to .</p>
<p>More than 1.5V — Normal</p> <p>Less than 1.5V — Defective</p> 	<p>Proceed to Check mechanical portion if blinking is found in checking .</p> <p>Proceed to Check electronic circuit block if blinking is not found in checking .</p> <p>Replace the battery</p> <ul style="list-style-type: none"> • If the watch functions after battery replacement, proceed to . • If the watch does not function, proceed to Check electronic circuit block.
<ol style="list-style-type: none"> Clean off the parts contaminated with battery electrolyte, such as the battery connection. (Rinse the insulator for battery with water.) Reassemble the movement. (Replace the battery with a new one.) Check to see if the setting functions and the current consumption are normal. <p>Note: If the battery connection or circuit block is completely corroded with rust and cannot be corrected by cleaning, replace it with a new one.</p>	<p>Be sure to wipe off battery electrolyte on the battery connection.</p> 

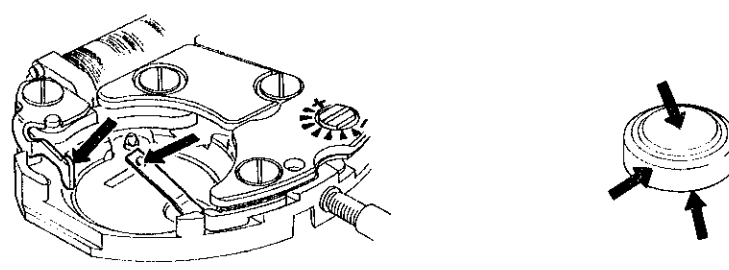
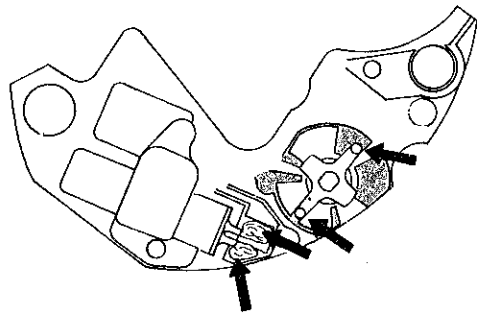
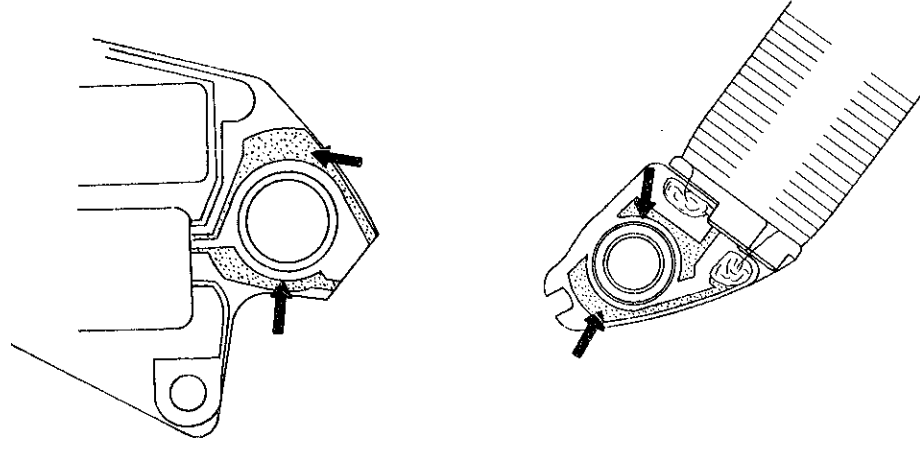
	Procedures	Results	Adjustment and repair
C CHECK BATTERY CONDUCTIVITY	<p>Check to see if the battery current flow to the circuit is normal. Check for any foreign matter on the connecting portions of the battery, the plus terminal of battery connection and the battery connection.</p> 	<p>Uncontaminated — Normal —></p> <p>Contaminated — Defective —></p>	<p>Proceed to D.</p> <p>Wipe off any foreign matter.</p> <div style="border: 1px solid black; padding: 5px; margin-top: 10px;"> <p>Note: Be careful not to bend the plus terminal of battery connection and the battery connection.</p> </div>
D CHECK CIRCUIT BLOCK CONDUCTIVITY	<p>Check for any short circuit and defective conductivity of the conductive portions of the circuit block. Disassemble the circuit block and check conductivity of the arrow-marked portions by using a microscope.</p> 	<p>No short circuit or defective conductivity — Normal —></p> <p>Short circuit and defective conductivity — Defective —></p>	<p>Proceed to E.</p> <p>Replace the circuit block with a new one.</p>
E CHECK CIRCUIT BLOCK OUTPUT TERMINAL CONDUCTIVITY	<p>Disassemble the circuit block and check the connecting portions of the circuit block output terminal and the coil block. Check for any foreign matter on the circuit block output terminal and the coil lead terminal.</p> 	<p>Uncontaminated — Normal —></p> <p>Contaminated — Defective —></p>	<p>Proceed to F.</p> <p>Wipe off any foreign matter.</p>

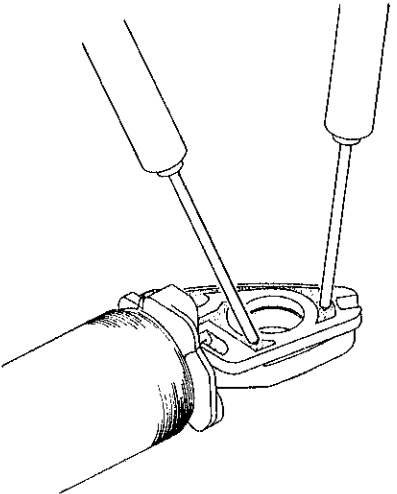
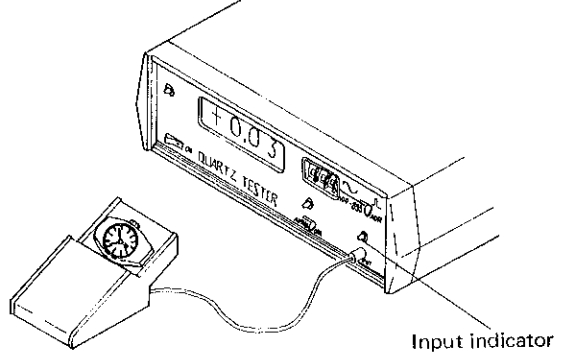
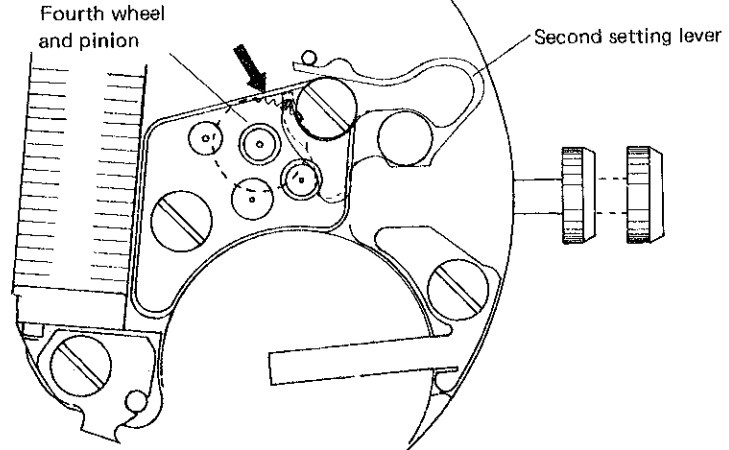
	Procedures	Results	Adjustment and repair
II CHECK COIL BLOCK	<p>Check for broken coil wire and short circuit of the coil block after disassembling the circuit block.</p> <ol style="list-style-type: none"> 1. Set up the Volt-ohm-meter. Range to be used: OHMS R x 100 2. Checking Apply the probes of the Volt-ohm-meter to the two coil lead terminals. <div data-bbox="192 604 875 714" style="border: 1px solid black; padding: 5px; margin-top: 10px;"> <p>Each of the red and black probes may touch either of the two coil lead terminals.</p> </div> 	<p>Pointer of the Volt-ohm-meter swings — Normal —></p> <p>Broken coil wire (Pointer of the Volt-ohm-meter hardly swings) — Defective —></p> <p>Short circuit (Pointer of the Volt-ohm-meter swings excessively) — Defective —></p>	<p>Proceed to II if the electronic circuit block must be checked. Proceed to III if the mechanical portion must be checked.</p> <p>Replace the coil block with a new one.</p>
G CHECK OUTPUT SIGNAL	<p>Check output signal.</p> <ol style="list-style-type: none"> 1. Set up the Quartz Tester. 2. Checking Follow the same procedures as in A. 	<p>Blinking —> Functioning (at 20-second intervals) —></p> <p>Blinking —> Not functioning —></p> <p>No blinking — Defective —></p>	<p>Proceed to K.</p> <p>Proceed to Check mechanical portion III.</p> <p>Replace the circuit block with a new one.</p>
I CHECK SECOND SETTING CONDITION	<p>Check to see if the second setting condition is normal. Check to see if there is clearance between the second setting lever and the fourth wheel and pinion when the crown is in the first click position and if the second setting lever touches the fourth wheel and pinion in the second click position. (Check through the hole of the third wheel bridge by using a microscope.)</p> <p>Check with the circuit block removed.</p> 	<p>Functions — Normal —></p> <p>Does not function — Defective —></p>	<p>Proceed to II.</p> <p>Correct the bend of the spring of the second setting lever if there is any. (If it is impossible to correct, replace the second setting lever with a new one.)</p>

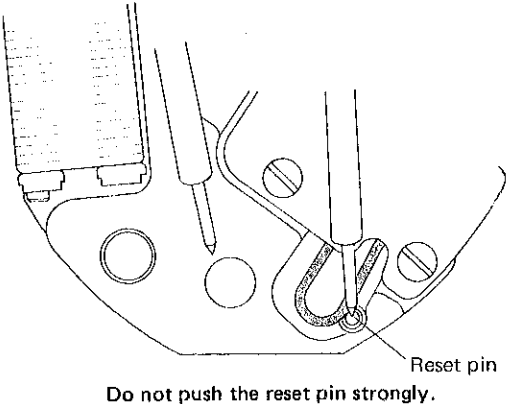
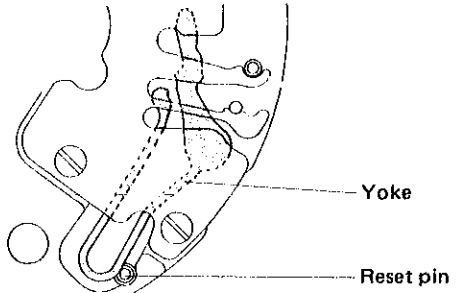
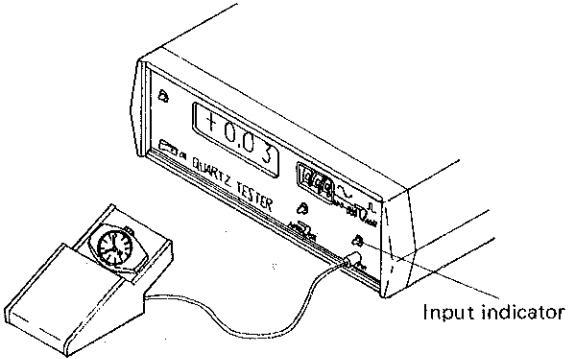
	Procedures	Results	Adjustment and repair
CHECK RESET CONDITION	<p>Check the reset condition after the circuit block and the battery are reassembled.</p> <p>(1) Check to see if the step rotor stops immediately when the crown is pulled out completely (hold for 20 seconds or more) and if it starts after 20 seconds when the crown is pushed in.</p> <p>(2) Check to see if the conductivity between the reset pin and the main plate is normal when the crown is pulled out completely.</p> <p>1. Set up the volt-ohm-meter. Range to be used: OHMS R x 1</p> <div data-bbox="270 541 1020 646" style="border: 1px solid black; padding: 5px;"> <p>Note: Be careful not to use the range other than R x 1. The circuit might be damaged if another range is used.</p> </div> <p>2. Checking Apply the probes to each of the main plate and the reset pin.</p> <div data-bbox="270 827 632 1003" style="border: 1px solid black; padding: 5px;"> <p>Each of the red and black probes may touch either of the main plate and the reset pin.</p> </div> 	<p>Stops completely and starts moving after 20 seconds — Normal →</p> <p>Does not stop or moves irregularly — Defective →</p> <p>Less than 10Ω — Normal →</p> <p>More than 10Ω — Defective →</p>	<p>Proceed to K.</p> <p>Proceed to L 2.</p> <p>Proceed to M.</p> <p>Make the repairs below as the contact between the reset pin and the yoke is defective.</p> <p>1. Check for the bend of the yoke and the reset pin and correct if any.</p>  <p>2. Check the contacting portions of the reset pin and the yoke for dust, lint and contamination and remove it if any.</p>
CHECK GEAR TRAIN	<p>Check the gear train with respect to the following points.</p> <p>1. Check for dust, lint and filings.</p> <p>2. Check for oil condition (quantity, deterioration, etc.).</p> <p>3. Check to see if the clearance is normal.</p>	<p>————— Normal —————→</p> <p>————— Defective —————→</p>	<p>Replace the circuit block with a new one.</p> <p>Correct the defective portions. (Removal of dust, lint and filings, relubricating and adjustment of clearance.)</p>
CHECK ACCURACY	<p>Check gain and loss of time.</p> <p>1. Set up the Quartz Tester.</p> <p>2. Checking Follow the same procedures as in A.</p> 	<p>————— Normal —————→</p> <p>————— Defective —————→</p>	<p>Follow the procedures in the Guide table for checking and adjustment on page 8.</p> <p>Proceed to Time accuracy adjusting (See page 2.)</p>

Procedures

In case a frequent battery change is required, a current consumption test is recommended. Measure the current consumption with the Volt-ohm-meter of as small range as possible ($12\mu\text{A}$ or less). The measurement with the SEIKO Volt-ohm-meter S-831 is described below.

Procedures:

1. Set up the Volt-ohm-meter.
 - Range to be used: DC $12\mu\text{A}$
 - Set up the condenser of $200\sim 500\mu\text{F}$ as shown in the photo.
 2. Set the watch.
 - Place the battery on the third wheel bridge with its minus side up.
 3. Measurement
 - Probe Red (+) ----- Battery connection
 - Probe Black (-) ----- Battery surface (-)
- Note:** Be sure to measure with the crown pushed in.

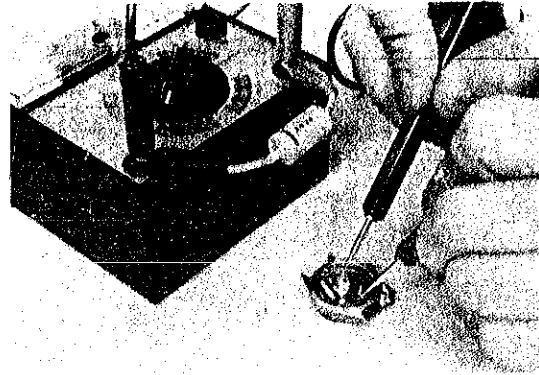

If the pointer of the Volt-ohm-meter scales out, proceed as follows: Reset the rotary step switch to DC 30mA and return to DC $12\mu\text{A}$ and measure with the probes applied.

Note: Cal. 2320A moves at 20-second intervals.
In order to get a stable reading, continue to measure for 2 to 3 minutes.

(Remarks)

The use of the Current Supplier (S-833), instead of placing the battery on the third wheel bridge, enables a surer measurement. (See the Instruction Manual for the Current Supplier S-833.)

Results

Less than $0.6\mu\text{A}$ ----- Normal ----->

More than $0.6\mu\text{A}$ ----- Defective ----->

Adjustment and repair

The current consumption is normal.

If the coil block is normal, replace the circuit block with a new one.

All procedures of Disassembling, Reassembling, Checking and Adjustment are completed.