

# PARTS CATALOGUE/ TECHNICAL GUIDE

## Cal. 3L12A Cal. 3L14A Cal. 3L19A

### [SPECIFICATIONS]

Cal. No.		3L12A	3L14A	3L19A
Item				
Movement		 <p>The illustrations refer to Cal. 3L12A. (x 1.5)</p>		
Movement size	Outside diameter	φ17.6 mm 15.3 mm between 3 o'clock and 9 o'clock sides	φ19.8 mm 17.1 mm between 3 o'clock and 9 o'clock sides	φ17.6 mm 15.3 mm between 3 o'clock and 9 o'clock sides
	Casing diameter	φ17.1 mm 15.3 mm between 3 o'clock and 9 o'clock sides	φ19.3 mm 17.1 mm between 3 o'clock and 9 o'clock sides	φ17.1 mm 15.3 mm between 3 o'clock and 9 o'clock sides
	Height	2.5 mm		
Time indication		3 hands	2 hands	
Driving system		Step motor (Load compensated driving pulse type)		
Additional mechanism		Date calendar		
		Instant date setting device		
		Train wheel setting device	—	
		Electronic circuit reset switch		
		Battery life indicator	—	
Loss/gain		Monthly rate at normal temperature range: less than 15 seconds		
Regulation system		Nil		
Measuring gate by quartz tester		Use 10-second gate.		
Battery		SEIKO TR621SW, Maxell SR621SW, SONY EVEREADY 364, U.C.C. 364 Battery life is approximately 3 years. Voltage: 1.55V		
Jewels		3 jewels		

# PARTS CATALOGUE

Cal. 3L12A, 3L14A, 3L19A

Disassembling procedures Figs.: ① → ③⑥  
 Reassembling procedures Figs.: ③⑥ → ①

**Lubricating: Types of oil**

● Moebius A  
 ○ SEIKO Watch Oil S-6

**Oil quantity**

○ Normal quantity  
 ○ Extremely small

Ex.: Cal. 3L12A

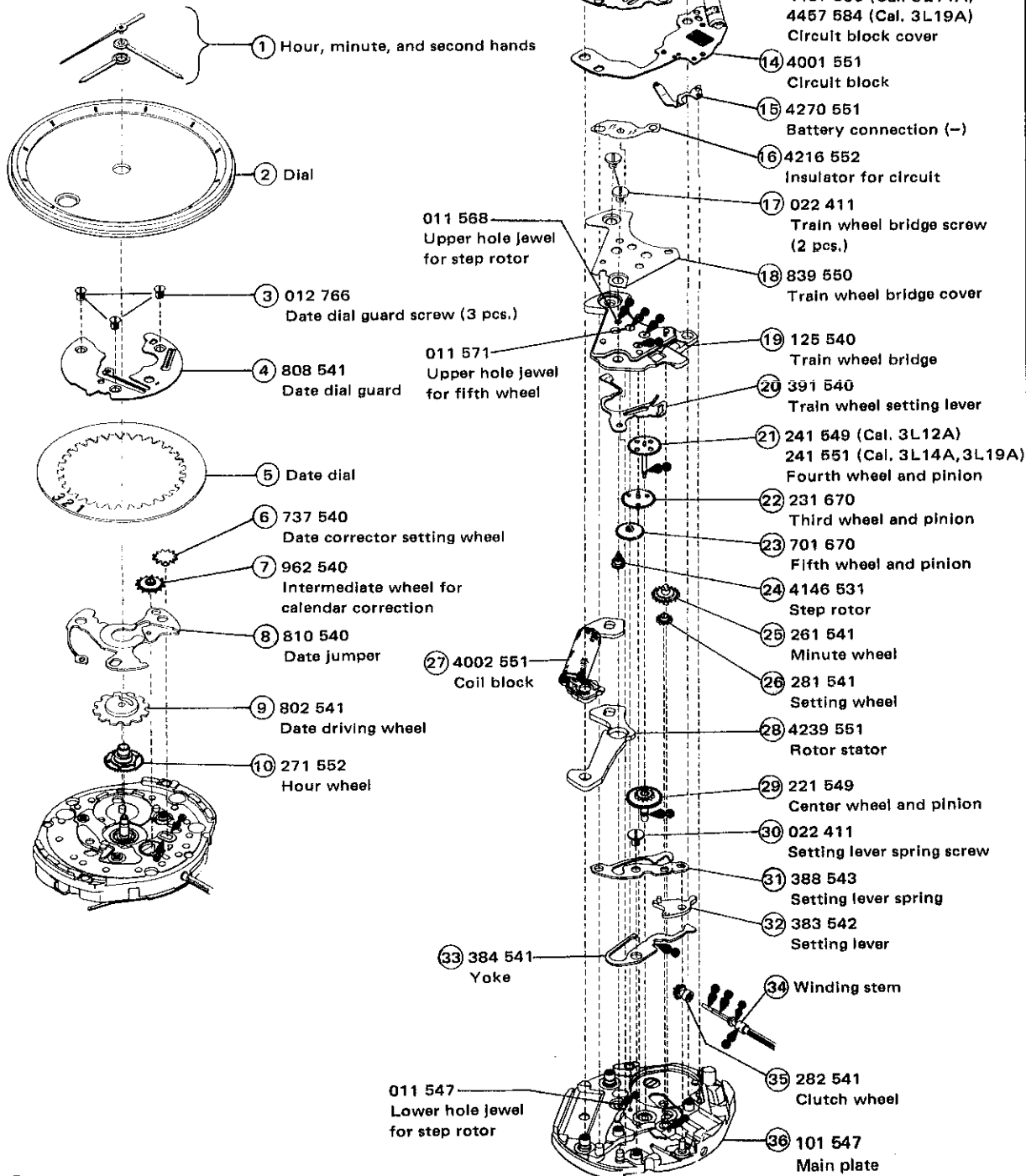

○ ➔ Please see the remarks on the following pages.

# PARTS CATALOGUE

Cal. 3L12A, 3L14A, 3L19A

**Remarks:**

⑤ Date dial

Cal. No.	Part code	Position of crown	Position of calendar	Color of figure	Color of background
3L12A 3L19A	801 756	3 o'clock	6 o'clock	Black	White
3L14A	801 822	3 o'clock	6 o'clock	Black	White

If any other type of date dial is required, please specify ① Cal. No., ② the crown position, ③ the calendar frame position, and ④ Dial No.

③④ Winding stem 351 546

The type of winding stem is determined based on the design of cases.  
Check the case number and refer to "SEIKO Casing Parts Catalogue" to choose a corresponding winding stem.

## TECHNICAL GUIDE

Cal. 3L12A, 3L14A, 3L19A

- The explanation here is only for the particular points of Cal. 3L12A, 3L14A, and 3L19A.
- For the repairing, checking and measuring procedures, refer to "TECHNICAL GUIDE, GENERAL INSTRUCTION".

### I. STRUCTURE OF THE CIRCUIT BLOCK

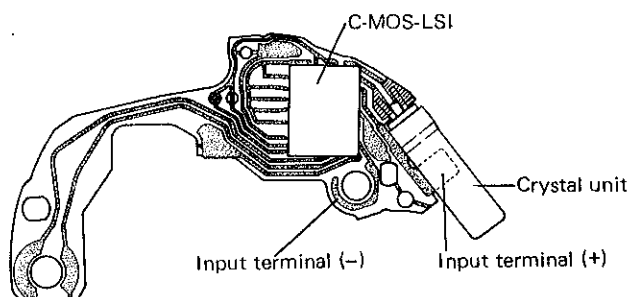

### II. REMARKS ON DISASSEMBLING AND REASSEMBLING

Use the universal movement holder for disassembling and reassembling.

⑧ Date jumper

- Lubricating

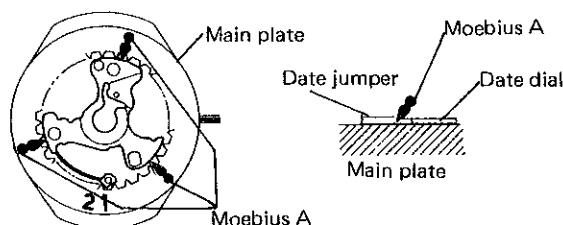

## 11 Battery

### ● Setting position

The plus lead terminal portion of the circuit block cover touches the side surface of the battery.

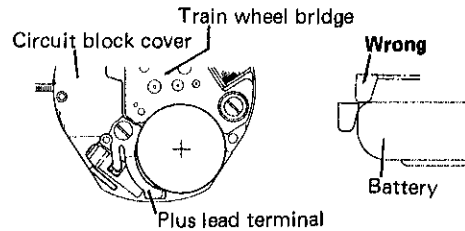

## 19 Train wheel bridge

### ● Setting position

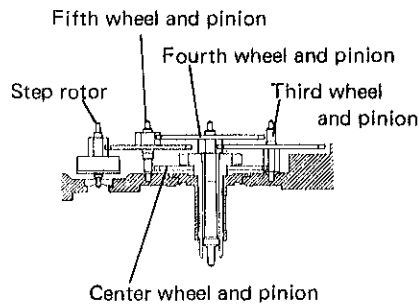
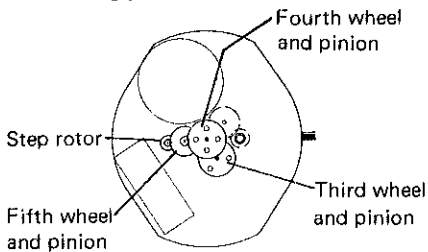

### ● Cleaning

Use Daiflon S-3 for cleaning.

## 20 Train wheel setting lever

### ● Setting position

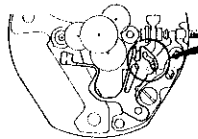

Enlarged

### ● Lubricating

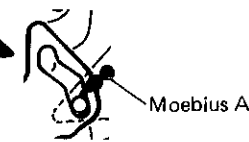

## 26 Setting wheel

### ● Installing

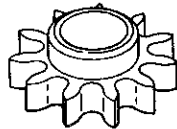

Cross section

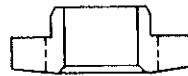

Downward

## 29 Center wheel and pinion

### ● Lubricating

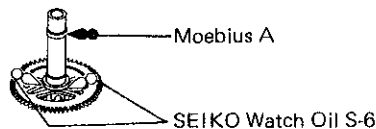

## III. VALUE CHECKING

### ● Coil block resistance

3.4KΩ ~ 4.1KΩ

### ● Current consumption

For the whole of the movement : less than 0.9μA  
 For the circuit block alone : less than 0.4μA

### Remarks:

When the current consumption exceeds the standard value for the whole of the movement but is less than the standard value for the circuit block alone, overhaul and clean the movement parts and then measure current consumption for the whole of the movement again. The driving pulse generated to compensate a heavy load that may apply on the gear train, etc. is considered to cause excessive current consumption for the whole of the movement.