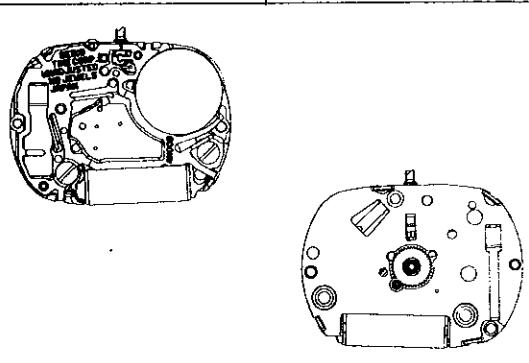
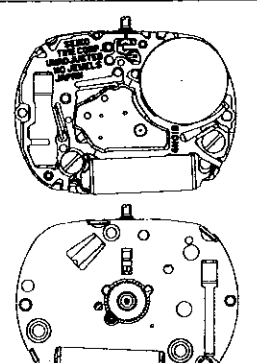

PARTS CATALOGUE/ TECHNICAL GUIDE

Cal. 4N00B, 4N20B

Cal. 4N01B

[SPECIFICATIONS]

Cal. No.		4N00B	4N20B	4N01B
Item				
Movement		 <p>The illustrations refer to Cal. 4N00B. (x2.0)</p>		 <p>(x 2.0)</p>
Movement size	Outside diameter	10.8mm between 3 o'clock and 9 o'clock sides 14.5mm between 6 o'clock and 12 o'clock sides		
	Casing diameter	φ13.9mm		
	Height	2.1mm		2.3mm
Time indication		2 hands (Move at 20-second intervals)		3 hands
Driving system		Step motor (Fixed-width pulse system)		Step motor (Load compensated driving pulse type)
Additional mechanism		—		Train wheel setting device
		Electronic circuit reset switch		
Loss/gain (Monthly rate at normal temperature range)		less than 20 seconds	less than 15 seconds	less than 20 seconds
Regulation system		Nil		
Measuring gate by quartz tester		Use 10-second gate.		
Battery		SEIKO SR516SW, Maxell SR516SW, SONY SR516SW, Matsushita SR516SW		SEIKO SR521SW, Maxell SR521SW, SONY SR521SW, EVEREADY 379
		Battery life is approximately 3 years.		Battery life is approximately 2 years.
		Voltage: 1.55V		
Jewels		0 jewel		

PARTS CATALOGUE

Cal. 4N01B

Disassembling procedures Figs.: ① → ②⑤
 Reassembling procedures Figs.: ②⑤ → ①

Lubricating: Types of oil
 ● Moebius A
 ○ SEIKO Watch Oil S-6

Oil quantity
 ● Normal quantity

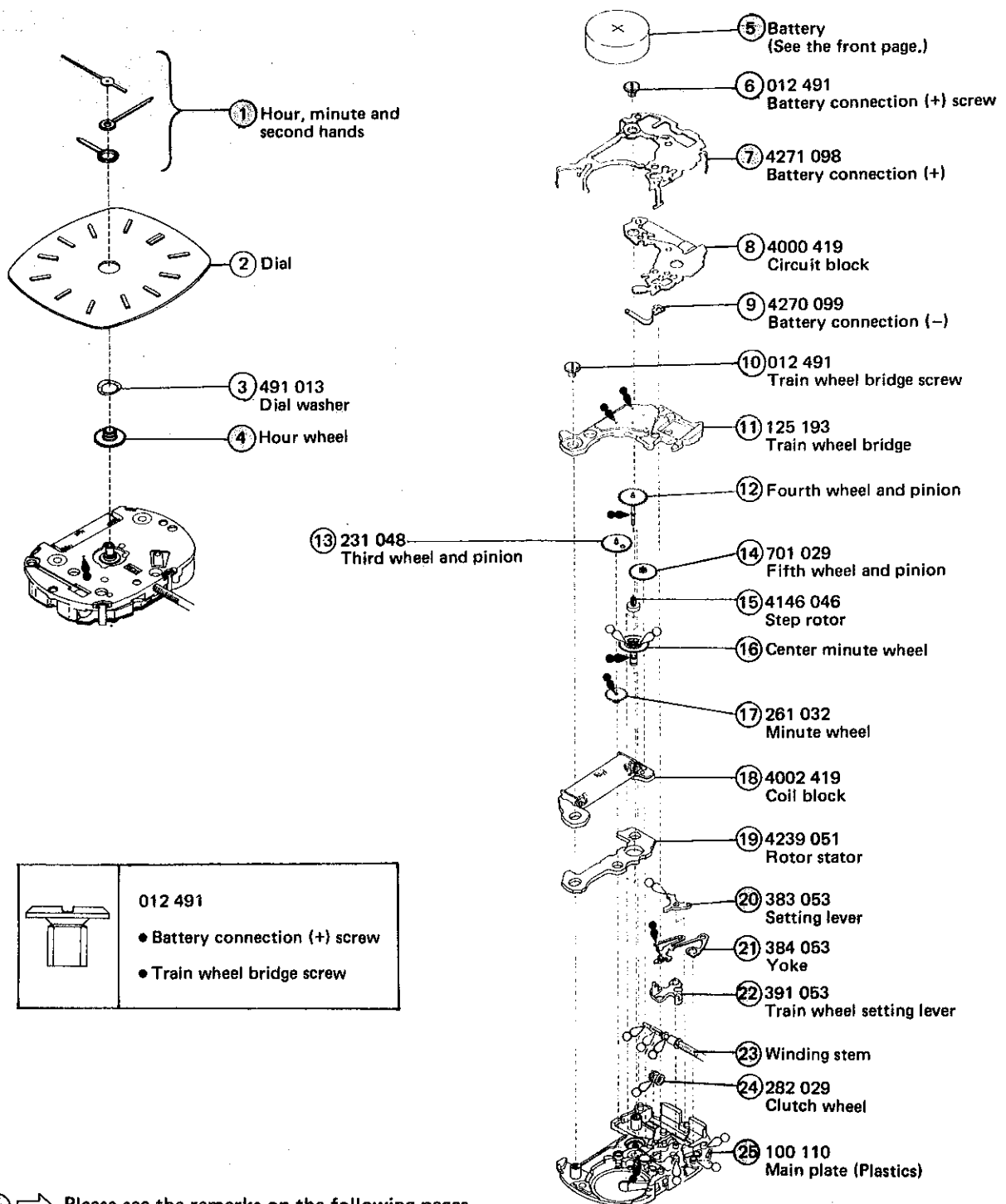

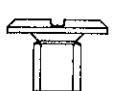
	012 491
	● Battery connection (+) screw
	● Train wheel bridge screw

⊙ → Please see the remarks on the following pages.

PARTS CATALOGUE

Cal. 4N00B, 4N20B

Disassembling procedures Figs.: (1) → (22)

Reassembling procedures Figs.: (22) → (1)

Lubricating: Types of oil

● Moebius A

○ SEIKO Watch Oil S-6

Oil quantity

● Normal quantity

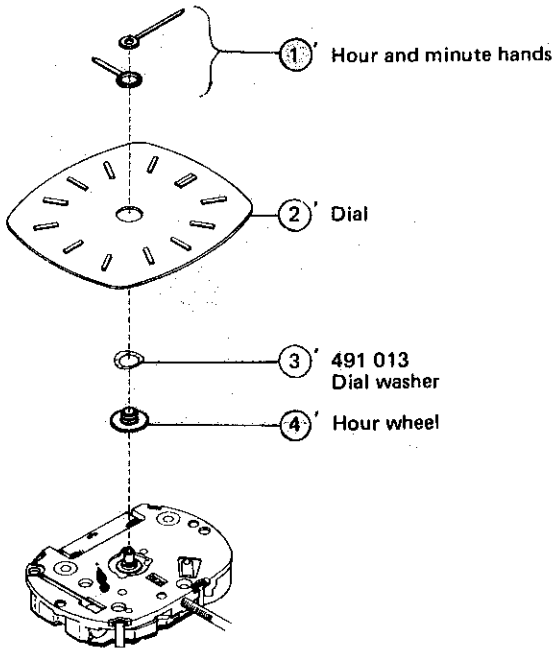

	012 491
	● Battery connection (+) screw
	● Train wheel bridge screw

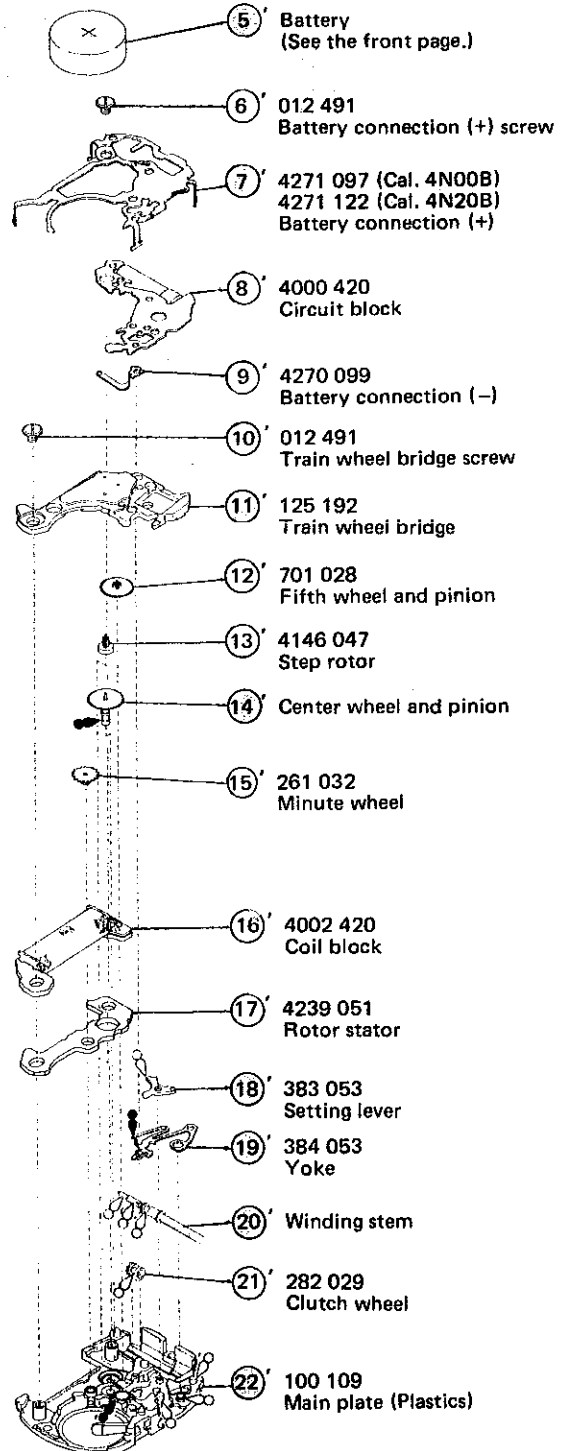

Please see the remarks on the following pages.

PARTS CATALOGUE

Cal. 4N00B, 4N01B, 4N20B

Remarks:

- ④ ④' Hour wheel
- ⑫ Fourth wheel and pinion (Only for Cal. 4N01B)
- ⑭' Center wheel and pinion (Only for Cal. 4N00B, 4N20B)
- ⑯ Center minute wheel (Only for Cal. 4N01B)

Combination:

[Cal. 4N00B]

Part name Type*	Hour wheel	Center wheel and pinion
M	271 463	221 048

[Cal. 4N01B]

Part name Type*	Hour wheel	Center minute wheel	Fourth wheel and pinion
M	271 296	270 296	241 131

[Cal. 4N20B]

Part name Type*	Hour wheel	Center minute wheel
M	271 464	221 046
L	271 463	221 048

* Abbreviation M ... Standard type
(Movement type) L ... Long type

Parts combination varies, depending on the design of cases. Refer to "SEIKO Casing Parts Catalogue".

- ⑳ ㉔' Winding stem
351 155, 351 156

The type of winding stem is determined based on the design of cases. Check the case number and refer to "SEIKO Casing Parts Catalogue" to choose corresponding types.

- ㉕ ㉒' Main plate

The main plate with a setting wheel is available for supply.

TECHNICAL GUIDE

Cal. 4N00B, 4N01B, 4N20B

- The explanation here is only for the particular points of Cal. 4N00B, 4N20B and 4N01B.
- For the repairing, checking and measuring procedures, refer to the "TECHNICAL GUIDE, GENERAL INSTRUCTIONS".

I. STRUCTURE OF THE CIRCUIT BLOCK

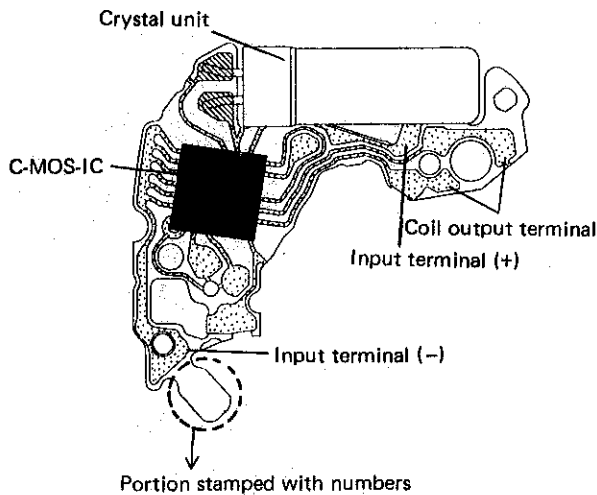

Note:

To identify the circuit blocks for the respective calibres, check the positions of the numbers printed on them. They are positioned differently according to the calibre as shown by the reticulated portions in the illustrations below. Also note that some of the circuit blocks for Cal. 4N01B do not have numbers printed on them.

Cal. 4N00B, 4N20B

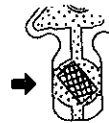

Cal. 4N01B

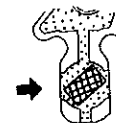

II. REMARKS ON DISASSEMBLING AND REASSEMBLING

① ① Hands

• How to install

When installing the hands, place the movement directly on a flat metal plate or the like, escaping the spring portion of the battery connection (+).

Cal. 4N00B, 4N20B

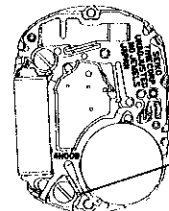

Cal. 4N01B

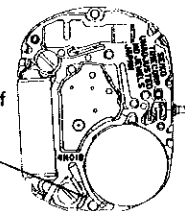

Spring portion of battery connection (+)

⑤ ⑤ Battery

• How to install

When installing the battery, check that the battery connection (+) securely touches the side face of the battery.

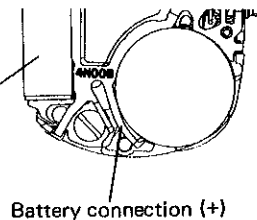

Wrong

Correct

Battery

Main plate

⑦ ⑦ Battery connection (+)

• How to install

Have the hook portions (4 places) catch the main plate (Fig. 1 & 2).

In disassembling and reassembling, take care not to deform the hook portions.

After installing the battery connection (+), check that the four hook portions securely catch the main plate.

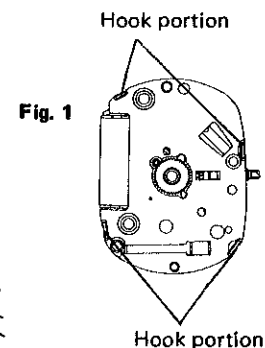
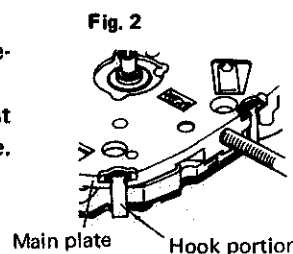

TECHNICAL GUIDE

Cal. 4N00B, 4N01B, 4N20B

⑪ ⑪ Train wheel bridge

● Setting position

Note:

Since the fifth wheel and pinion and step rotor are made of plastics, take care not to damage them in disassembling and reassembling.

Cal. 4N00B, 4N20B

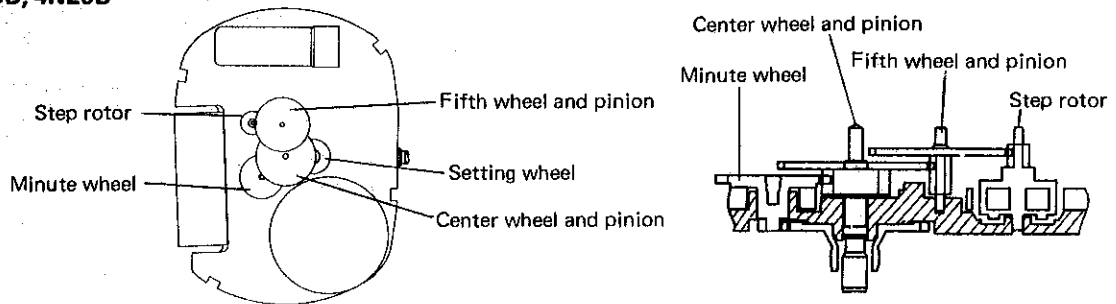

Cal. 4N01B

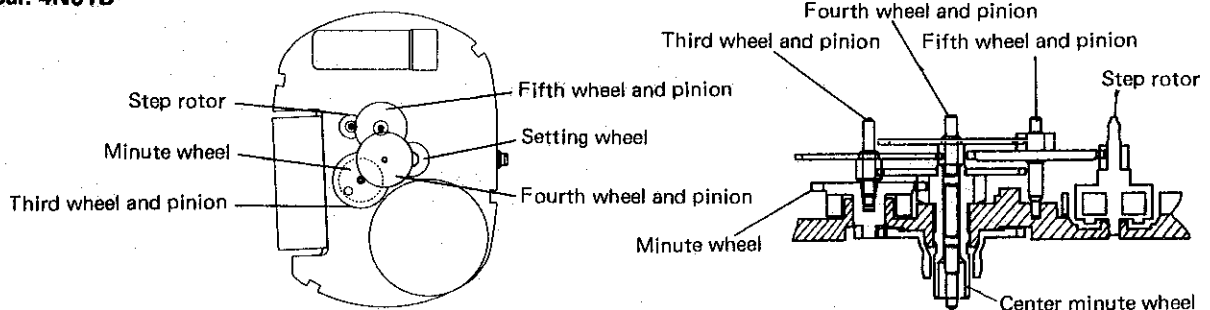

⑳ ⑱ Setting lever

㉑ ⑲ Yoke

㉒ Train wheel setting lever (Only for Cal. 4N01B)

● Setting position

Cal. 4N00B, 4N20B

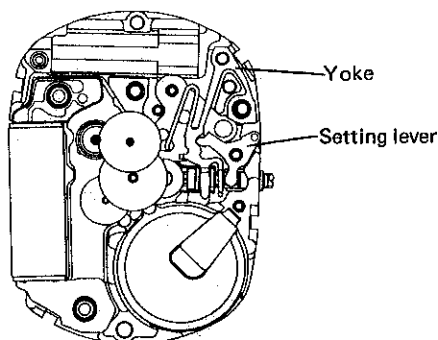

Cal. 4N01B

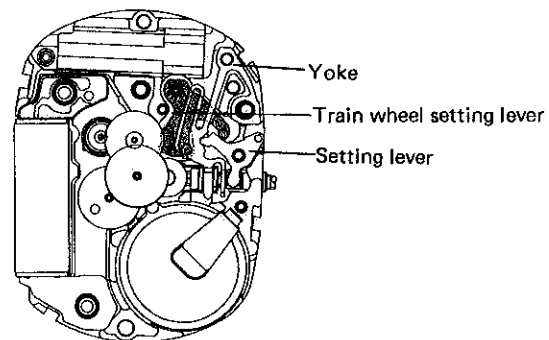

Notes:

- Take care not to deform the spring portion of the yoke.
- Since the train wheel setting lever is made of plastics and easily damaged, lightly catch it with tweezers taking care not to touch the portion engaging with the fifth wheel and pinion.

TECHNICAL GUIDE

Cal. 4N00B, 4N01B, 4N20B

(25) (22) Main plate

● Lubricating

Notes:

- Since the setting wheel is fixed securely to the main plate with a pin, never disassemble them apart.
- Apply a liberal quantity of Moebius A to the setting wheel.

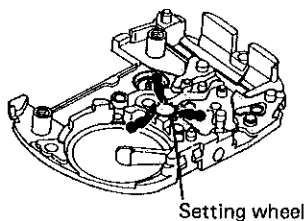

III. VALUE CHECKING

Cal. No.		4N00B, 4N20B	4N01B
Coil block resistance		2.0K Ω ~ 2.4K Ω	2.1K Ω ~ 2.5K Ω
Current consumption	For the whole of the movement	less than 0.5 μ A	less than 1.1 μ A
	For the circuit block alone	less than 0.3 μ A	less than 0.3 μ A

Remarks:

When the current consumption exceeds the standard value for the whole of the movement but is less than the standard value for the circuit block alone, overhaul and clean the movement parts and then measure current consumption for the whole of the movement again. The driving pulse generated to compensate a heavy load that may apply on the gear train, etc. is considered to cause excessive current consumption for the whole of the movement.