

# TECHNICAL GUIDE

## SEIKO DIGITAL QUARTZ

CAL.A039A

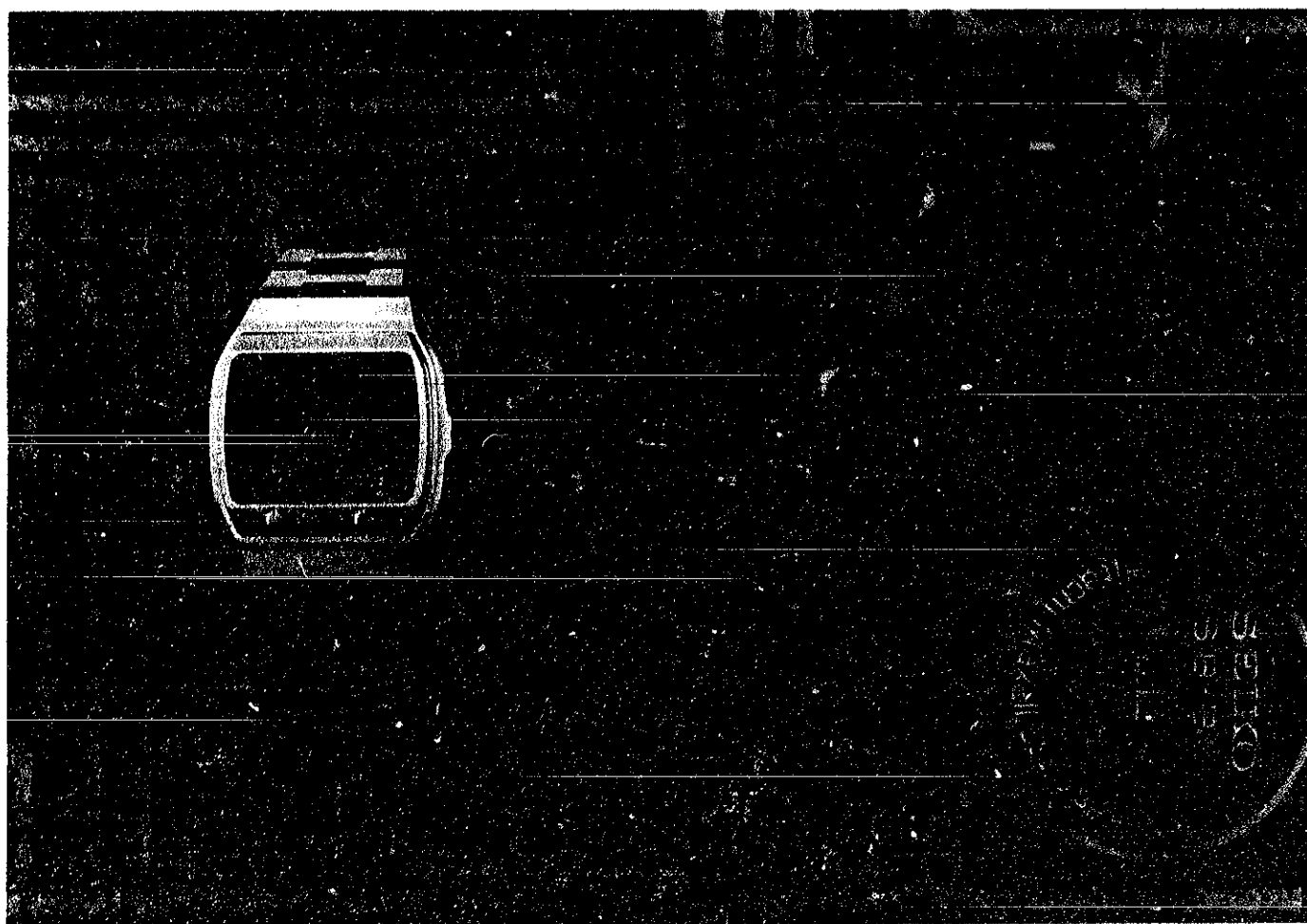

### CONTENTS

	<i>Page</i>
<b>I. SPECIFICATIONS AND FEATURES</b> .....	1
1. Specifications .....	1
2. Features .....	1
<b>II. DISPLAY AND BUTTON OPERATION</b> .....	2
1. Display .....	2
2. Button operation .....	2
3. Display adjustment .....	3
4. How to set the timer, alarm and automatic alarm .....	4
<b>III. ALARM SOUNDING MECHANISM AND OUTLINE OF FUNCTIONING</b> .....	5
1. Outline of functioning .....	5
2. Structure .....	6
<b>IV. BATTERY LIFE INDICATOR</b> .....	6
<b>V. AFTER-SALE SERVICING INSTRUMENTS AND MATERIALS</b> .....	7
<b>VI. CASE</b> .....	8
<b>VII. DISASSEMBLING, REASSEMBLING, LUBRICATING AND CLEANING</b> .....	10
1. Liquid crystal panel side .....	10
2. Switch mechanism side .....	12
3. Cleaning .....	14
<b>VIII. CHECKING AND ADJUSTMENT</b> .....	15
1. Guide table for checking and adjustment .....	15
2. Malfunction and checking points .....	16
3. Procedures for checking and adjustment .....	17
A. Check battery voltage .....	17
B. Check battery conductivity .....	17
C. Check conductivity of liquid crystal panel, circuit block and connector .....	18
D. Check switch component .....	19
E. Check circuit block and liquid crystal panel .....	20
F. Check current consumption .....	21
G. Check accuracy .....	22
H. Check alarm sounding condition .....	22
I. Check bulb condition .....	23
J. Check battery life indicator .....	23
K. Check functioning .....	24

Calibre A039A

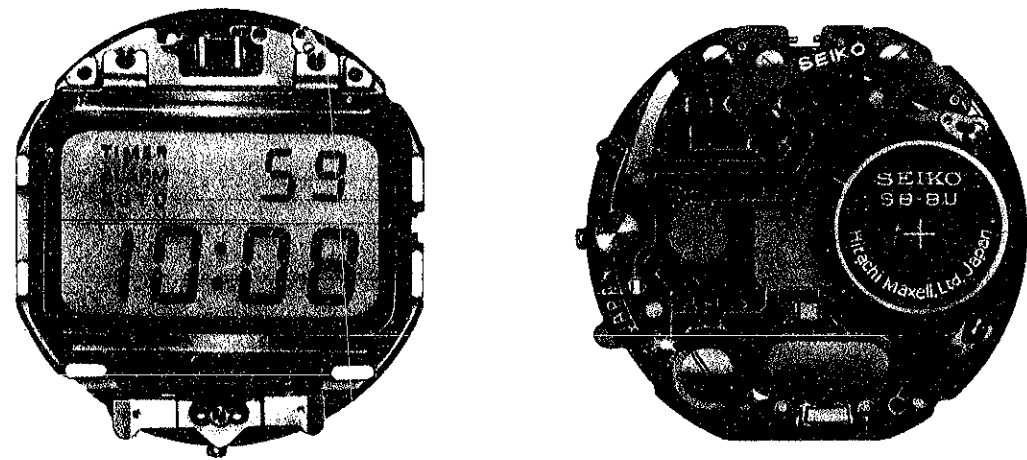

Movement

## I. SPECIFICATIONS AND FEATURES

### 1. Specifications

Item	Calibre No. A039A
Display medium	Nematic Liquid Crystal, FEM (Field Effect Mode)
Display system	Time and calendar display Hour, minute and second: 24-hour Digital Display System Date: Automatic calendar system (The automatic calendar system automatically adjusts even and odd months except February.) TIMER: Hour, minute & second: 24-hour Digital Display System ALARM: Hour & minute: 24-hour Digital Display System AUTOMATIC ALARM: Hour & minute: 24-hour Digital Display System
Additional mechanism	Battery life indicator Alarm (Crystal sound system) <ul style="list-style-type: none"> <li>Starts sounding at the required alarm time (Once for 10 seconds at a time.)</li> <li>Starts sounding every hour on the hour (When both the minute digits and the second digits indicate "00". If the date digits are displayed, the alarm does not operate.)</li> </ul> Illuminating light Alarm volume control device
Crystal oscillator	32,768 Hz (Hz = Hertz . . . Cycles per second)
Loss/gain	Loss/gain at normal temperature range Mean monthly rate: less than 15 seconds (Annual rate: less than 3 minutes)
Casing diameter	φ28.4 mm (27.0 mm between 3 o'clock and 9 o'clock sides)
Height	6.7 mm
Operational temperature range	-10°C ~ +60°C (14°F ~ 140°F)
Regulation system	Trimmer condenser
Battery power	SEIKO SB-BU silver oxide battery, 1.5 V Battery life is approximately two years. (If the light is used 5 times a day and the alarm is used three times a day.)
IC (Integrated Circuit)	C-MOS-LSI . . . 1 piece Bipolar-IC . . . 1 piece

### 2. Features

In addition to displaying hour, minute, second and calendar digits, the SEIKO Digital Quartz Cal. A039A is the multi-function watch and capable of sounding alarm every hour on the hour and the required alarm time. The required time can be set in the Timer function, Alarm function and Automatic alarm function independently.

## II. DISPLAY AND BUTTON OPERATION

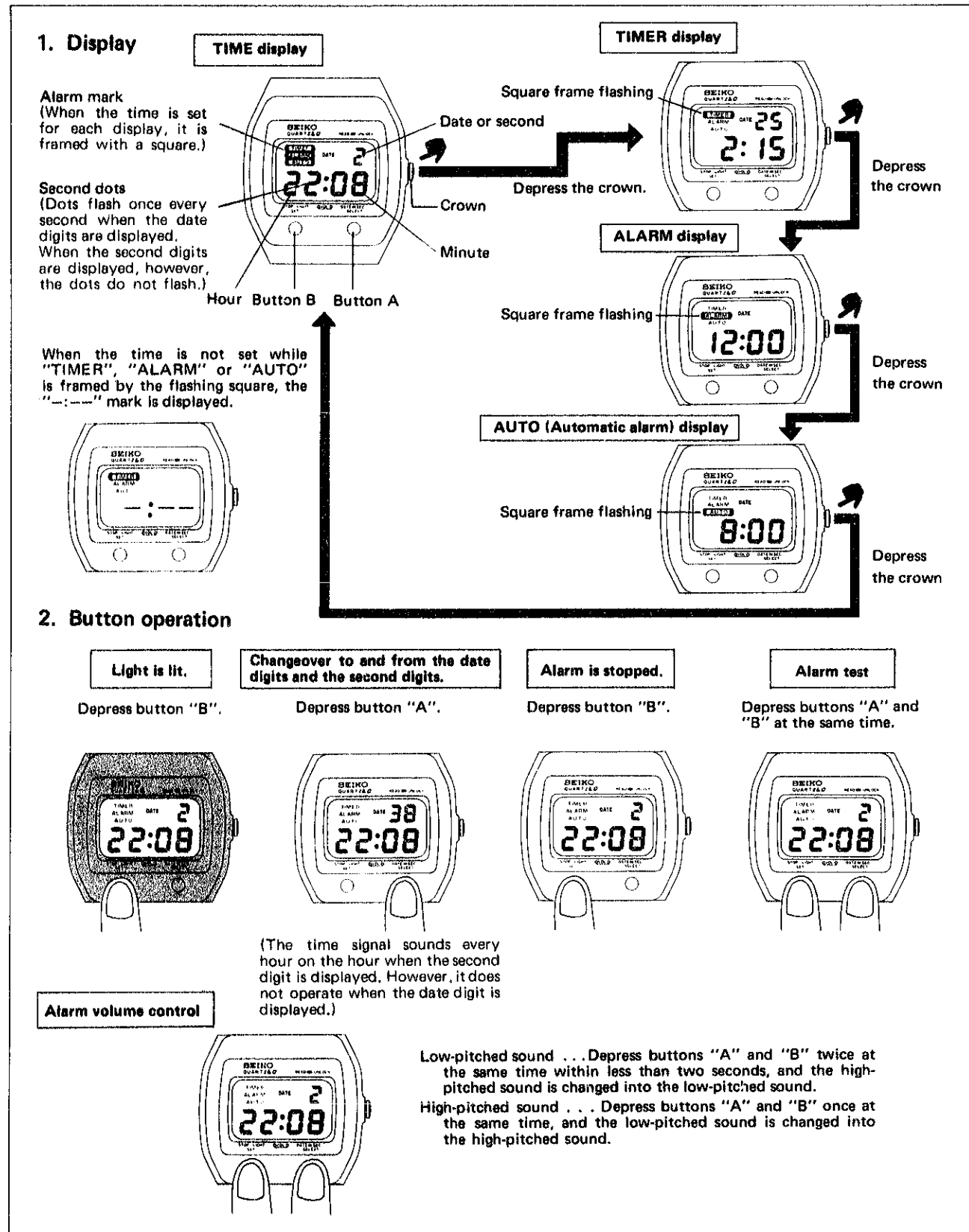

### 3. Display adjustment

#### • How to set the time and calendar

[Example]

The illustration shows that the indication of 10:18:42 A.M., May 10, is changed into 7:00:00 P.M., August 21.

Button Operation (SELECT and SET)		
Digits and mark to be adjusted	SELECT (Selection of the digits to be adjusted.)	SET (Adjustment)
Second	Pull out the crown and the second digits start flashing. (Even if the date digit is displayed, it is automatically changed into the second digit when the crown is pulled out.)	Depress button "B" and the seconds are then reset to "00".*
Hour	Depress button "A" and the hour digits start flashing.	One digit (hour) is advanced by each depression of button "B".
Minute (10-minute)	Depress button "A" and only the 10-minute digit starts flashing.	One digit (10 minutes) of the 10-minute digit is advanced by each depression of button "B".
Minute (1-minute)	Depress button "A" and only the 1-minute digit starts flashing.	One digit (minute) of the 1-minute digit is advanced by each depression of button "B".
Month	Depress button "A" and the month and date digits are displayed and the month digit starts flashing.	One digit (month) is advanced by each depression of button "B". The month digit is not displayed constantly but it is displayed only while the calendar digits are adjusted. Thus the date digit can be automatically adjusted for even and odd month. (except February)
Date	Depress button "A" and the date digits start flashing.	One digit (date) is advanced by each depression of button "B".
End of procedures	After all the adjustments are completed, depress the crown in to the normal position.	Each depression of button "A" will select the digits (flashing) to be adjusted in the following order. Second → Hour → 10-minute → 1-minute → Month → Date

\* (Depress button "B" in accordance with "00" second of a time signal and the seconds are then reset to "00" and start immediately. When the second count any numbers from "00" to "29", the seconds are reset to "00" automatically whenever button "B" is depressed. When the seconds count any numbers from "30" to "59" and button "B" is depressed, one minute is added and the seconds immediately return to "00".)

#### 4. How to set the timer, alarm and automatic alarm

##### 1) TIMER

How to sound the alarm after the desired amount of time is elapsed.

- Push the crown once when the time and calendar digits are displayed to start the "TIMER" mark square flashing. Then pull out the crown and depress buttons "A" and "B" to set the desired amount of time to be elapsed. (Refer to "How to set the time and calendar" for setting the time.)
- If the desired amount of time is set as shown in the illustration and when the crown is pushed in to the normal position, the second starts counting backward, and the alarm sounds after 2 hours and 15 minutes elapsed.
- The desired amount of time is reduced by one second, for example "35, 34, 33 . . ." as shown in the illustration.
- Backward counting of the desired amount of time is stopped when the crown is pulled out and it is re-started when the crown is pushed in to the normal position.
- When all time is elapsed, the "--:--" mark is displayed with a sound and the alarm time is released.

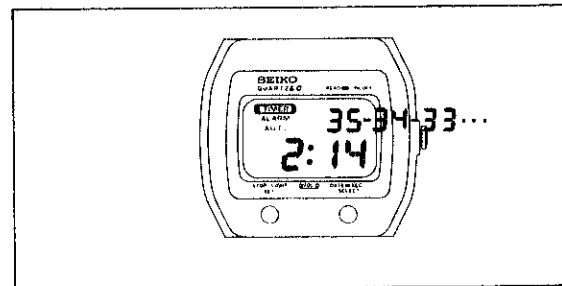
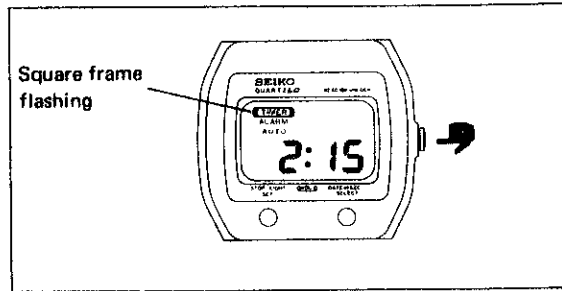

##### 2) ALARM

How to sound the alarm at the desired time

- Push the crown twice when the time and calendar digits are displayed to start the "ALARM" mark square flashing. Then pull out the crown and depress buttons "A" and "B" to set the alarm time. (Refer to "How to set the time and calendar" for setting the time.)
- The alarm starts sounding on 8:00:00 A.M. with the time digit automatically reset to "--:--" if the desired time is set as illustrated on the left and the alarm time is released.

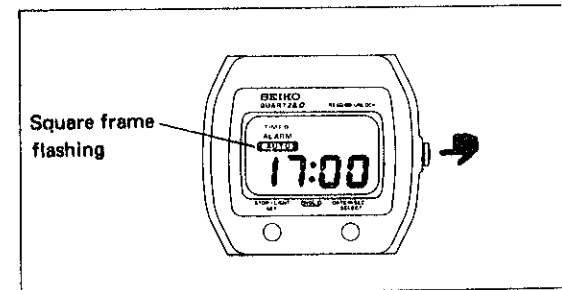
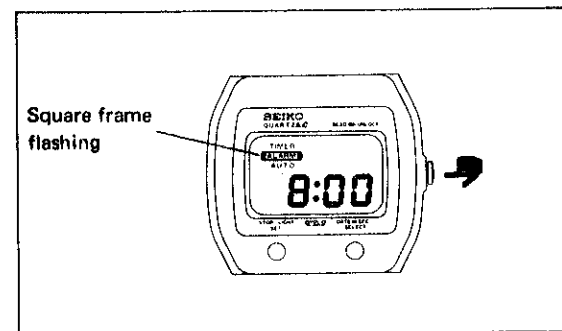

##### 3) AUTOMATIC ALARM

How to sound the alarm at the desired time every day

- Push the crown three times when the time and calendar digits are displayed to start the "AUTO" mark square flashing. Then pull out the crown and depress buttons "A" and "B" to set the desired time. (Refer to "How to set the time and calendar" for setting the time.)
- The alarm starts sounding on 17:00:00 (5:00:00 P.M.) every day if the desired time is set as illustrated on the left.

##### 4) How to release the alarm time

- The alarm time for "ALARM" and "AUTOMATIC ALARM" can be released with the same procedures.

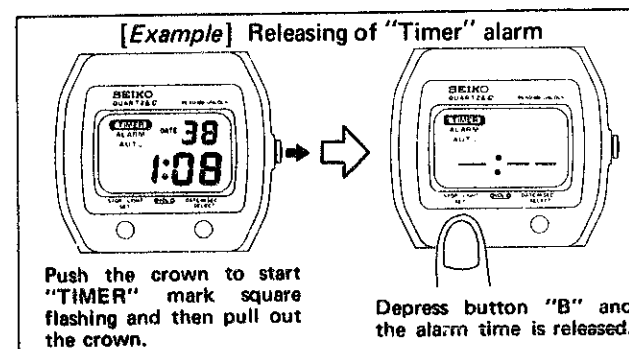

##### 5) How to stop the alarm

- The alarm goes on sounding for ten seconds at the required alarm time. Depress button "B" to stop the alarm.

Note:

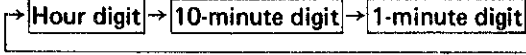
- Selection and adjustment of the digits in "TIMER", "ALARM" and "AUTO" are made in the following order:  

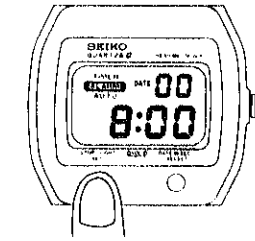
- Each different time for "TIMER", "ALARM" and "AUTO" can be set independently so that alarm starts sounding at each desired time for "TIMER", "ALARM" and "AUTO"



### III. ALARM SOUNDING MECHANISM AND OUTLINE OF FUNCTIONING

#### 1. Outline of functioning

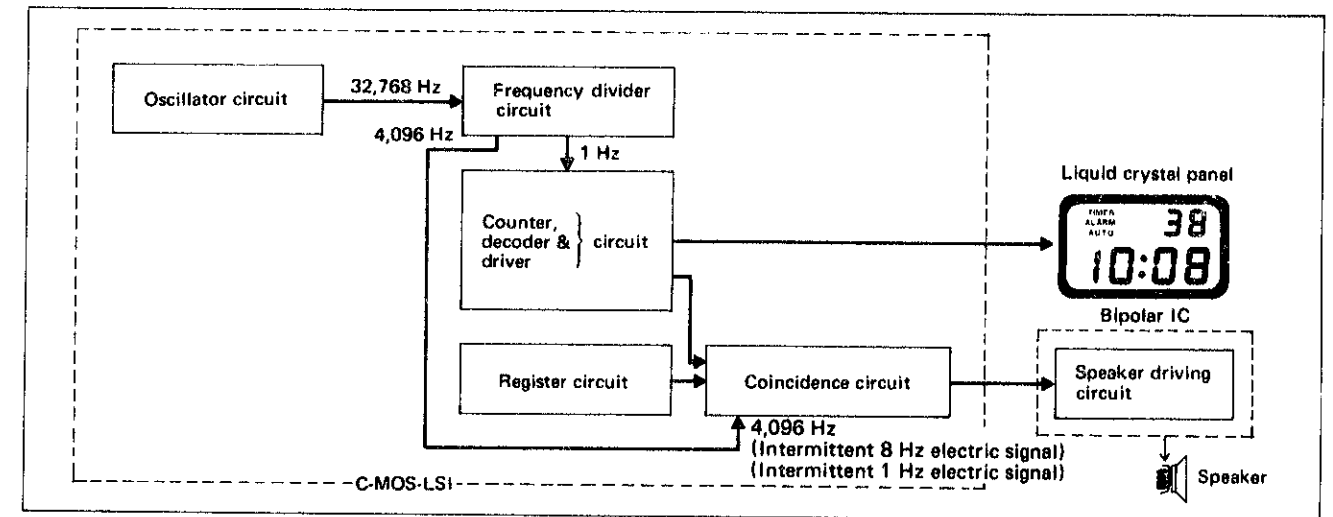
The register circuit, the coincidence circuit and the speaker driving circuit are specially designed for the alarm operation.



- (1) The register circuit memorizes the alarm time.
- (2) The coincidence circuit checks the displayed time on the liquid crystal panel with the alarm time memorized by the register circuit. When the two times coincide, the coincidence circuit sends a signal to the speaker driving circuit and orders it to operate the alarm. This is the electric signal that is converted into an intermittent 8 Hz electric signal (AUTOMATIC ALARM) or 1 Hz electric signal (TIMER, ALARM) from 4,096 Hz electric signal, which is taken out of the frequency divider circuit.
- (3) The speaker driving circuit amplifies the electric signal received from the coincidence circuit into such signal that is most suitable for operating the speaker.
- (4) When the speaker coil receives the electric signal, the coil becomes magnetized and vibrates the armature (metal diaphragm).
- (5) The vibration of the armature (metal diaphragm) causes the sound diaphragm to be resonant and produce the alarm sound.

## 2. Structure

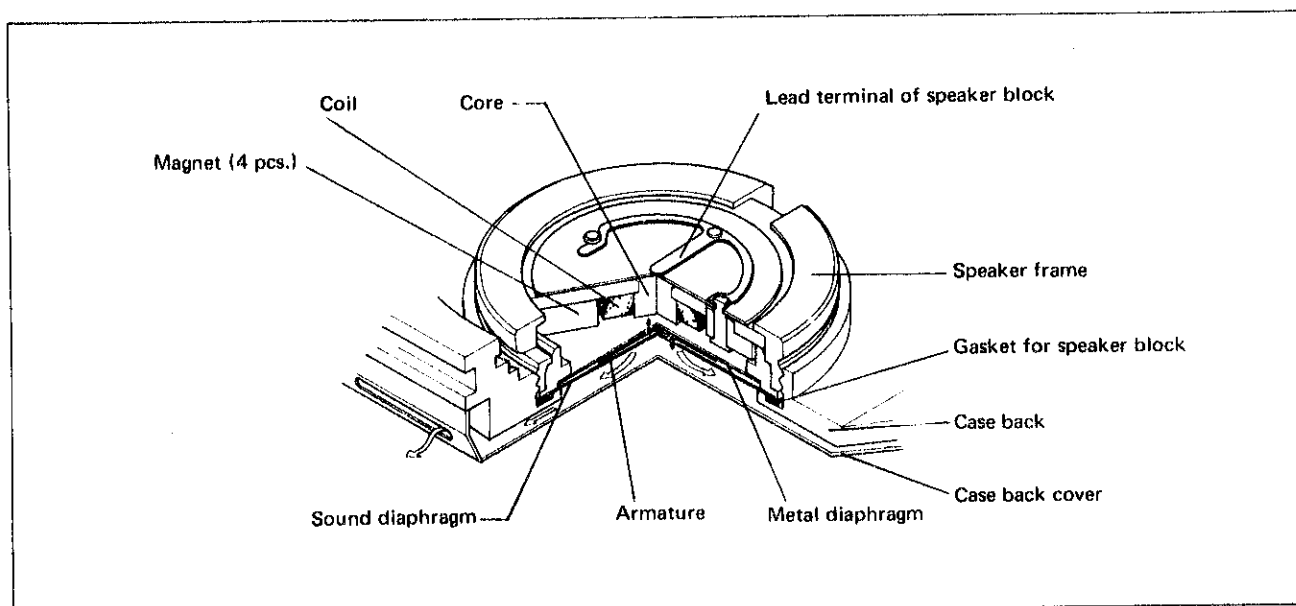

The speaker used in the SEIKO Digital Quartz Cal. A039A has been specially developed for SEIKO alarm watches and is excellent in durability, shock and humidity. Also, the speaker is so designed that it gives sufficient volume of sound with the lowest possible consumption of current.

## IV. BATTERY LIFE INDICATOR

The battery needs to be replaced when you see the entire display flashing. The watch will, however, remain accurate while the entire display is flashing.

### [Remarks for battery change]

Incomplete or flashing display may be indicated on the display panel after the battery is replaced. However, this is not a malfunction. Correct digital display will be indicated on the display panel by adjusting the time displays.

## V. AFTER-SALE SERVICING INSTRUMENTS AND MATERIALS

For after-sale servicing of SEIKO Quartz Digital Cal. A039A, the following after-sale servicing instruments and materials are necessary.

### 1. Quartz Tester

Used to check time accuracy.

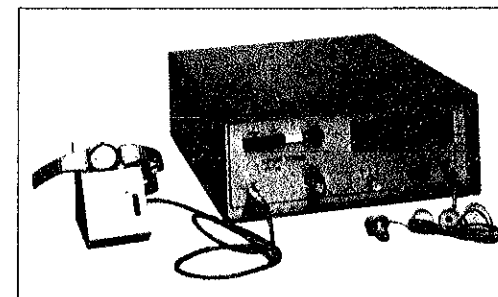

### 2. Micro-test MT-10II

Used to check the current consumption and supplies of the voltage power constantly.

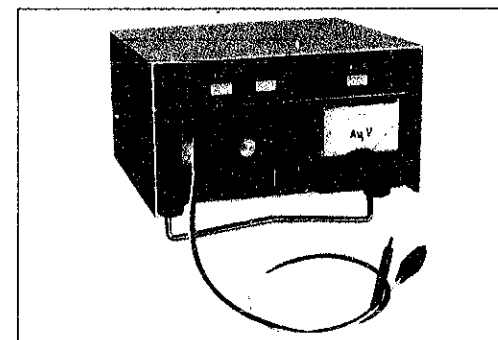

### 3. Volt-ohm-meter

Used to check the battery voltage and its conductivity.

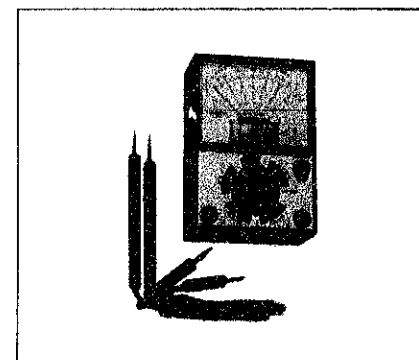

### 4. Movement holder (S-644)

Used for disassembling and reassembling of the movement.

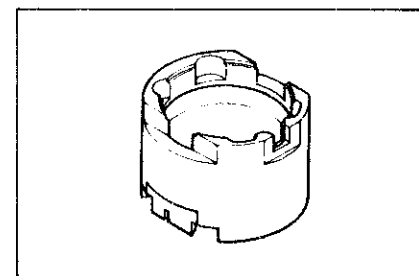

### 5. Battery holding spring (S-813)

Used for securing battery and flowing current when the movement is removed from the case.

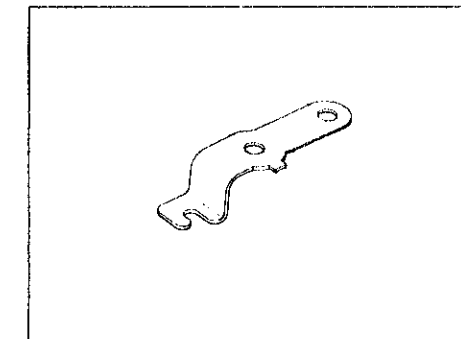

### 6. Static electricity protector (S-830)

Used to protect the circuit block from being damaged by static electricity.

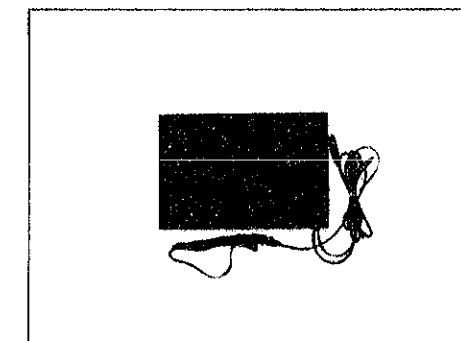

### 7. Speaker frame opener (S-832)

Used for disassembling and reassembling of the speaker block in the case back.

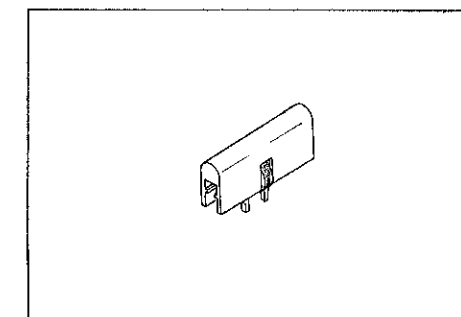

## VI. CASE

Disassembling procedures Figs.: ① ~ ⑫  
 Reassembling procedures Figs.: ⑫ ~ ①

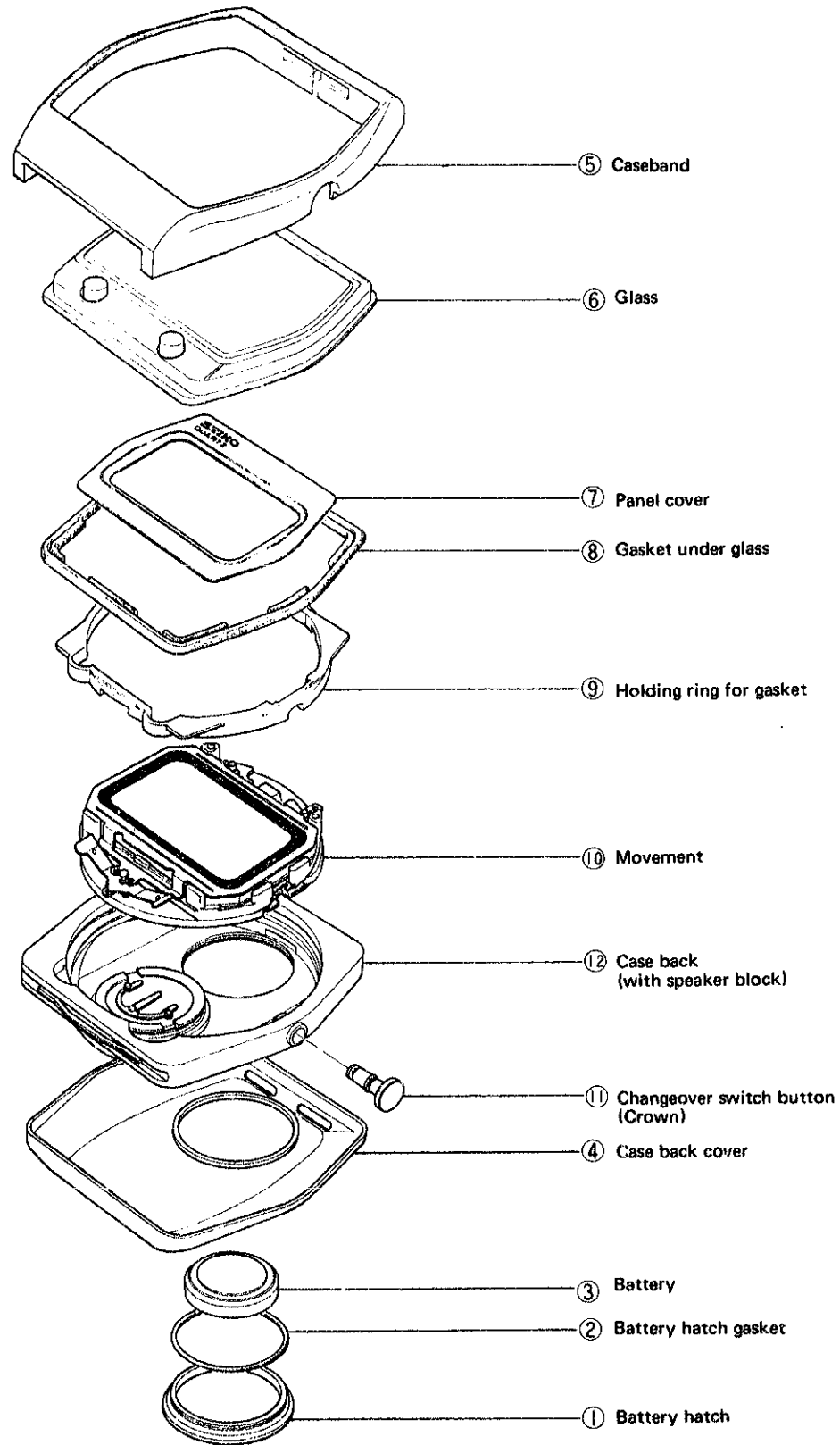

### Remarks for disassembling and reassembling

① **Battery hatch**  
 As the case back cover is secured by the battery hatch, remove the battery hatch first when the watch is disassembled.

⑥ **Glass**  
 Before reassembling the glass, wipe off dust and lint around the time adjusting buttons. (buttons A and B)  
 (Disassemble the hook-ups for the time adjusting buttons ("C" clamps) first and then the time adjusting buttons before removing dust and lint.)

⑩ **Movement**  
 • *Disassembling*  
 Turn the movement holding levers "A" and "B" in the arrow-marked direction to disassemble the movement.

• *Reassembling*  
 ○ Hook the switch lever of the switch block to the groove of the changeover switch button.  
 ○ Turn the movement holding levers "A" and "B" in the arrow-marked direction to reassemble the movement.

⑫ **Case back**  
 • *How to disassemble the speaker block*  
 Do not disassemble the speaker block except when replacement of parts or repair is necessary. Use speaker frame opener (S-832) for the disassembling of the speaker frame (Screw ring).

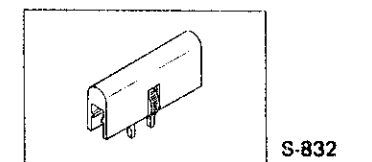
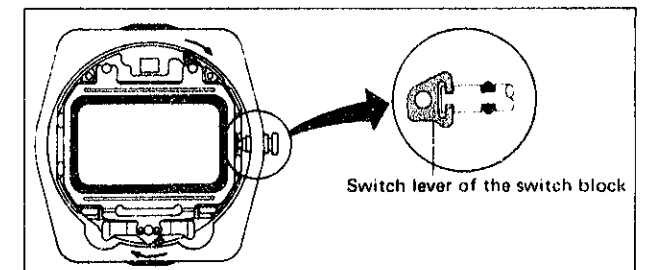
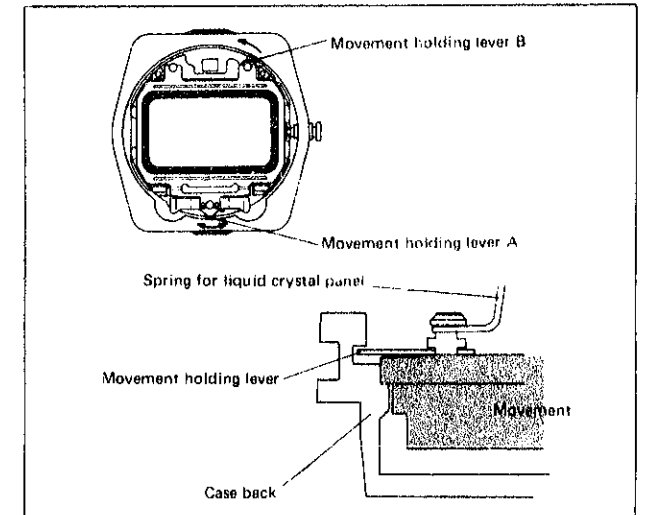
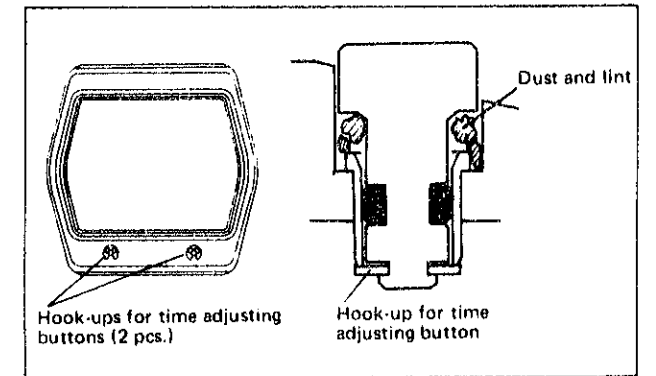
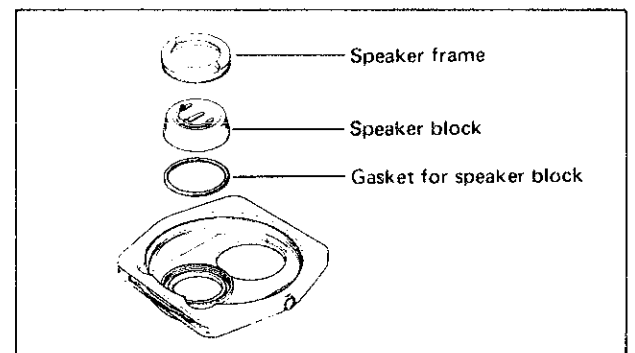

• *How to disassemble the sound diaphragm of the speaker block*

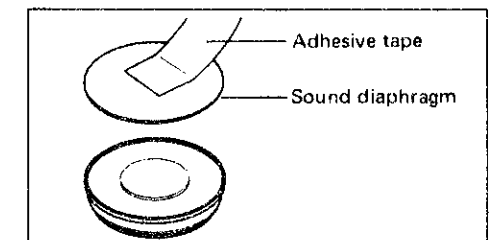

\* Do not disassemble the sound diaphragm of the speaker block except when replacement of the sound diaphragm is necessary.

## VII. DISASSEMBLING, REASSEMBLING, LUBRICATING AND CLEANING

### 1. Liquid crystal panel side

Disassembling procedures Figs.: ① ~ ⑰  
 Reassembling procedures Figs.: ⑰ ~ ①  
 Lubricating  : SEIKO Watch Oil S-6, normal quantity

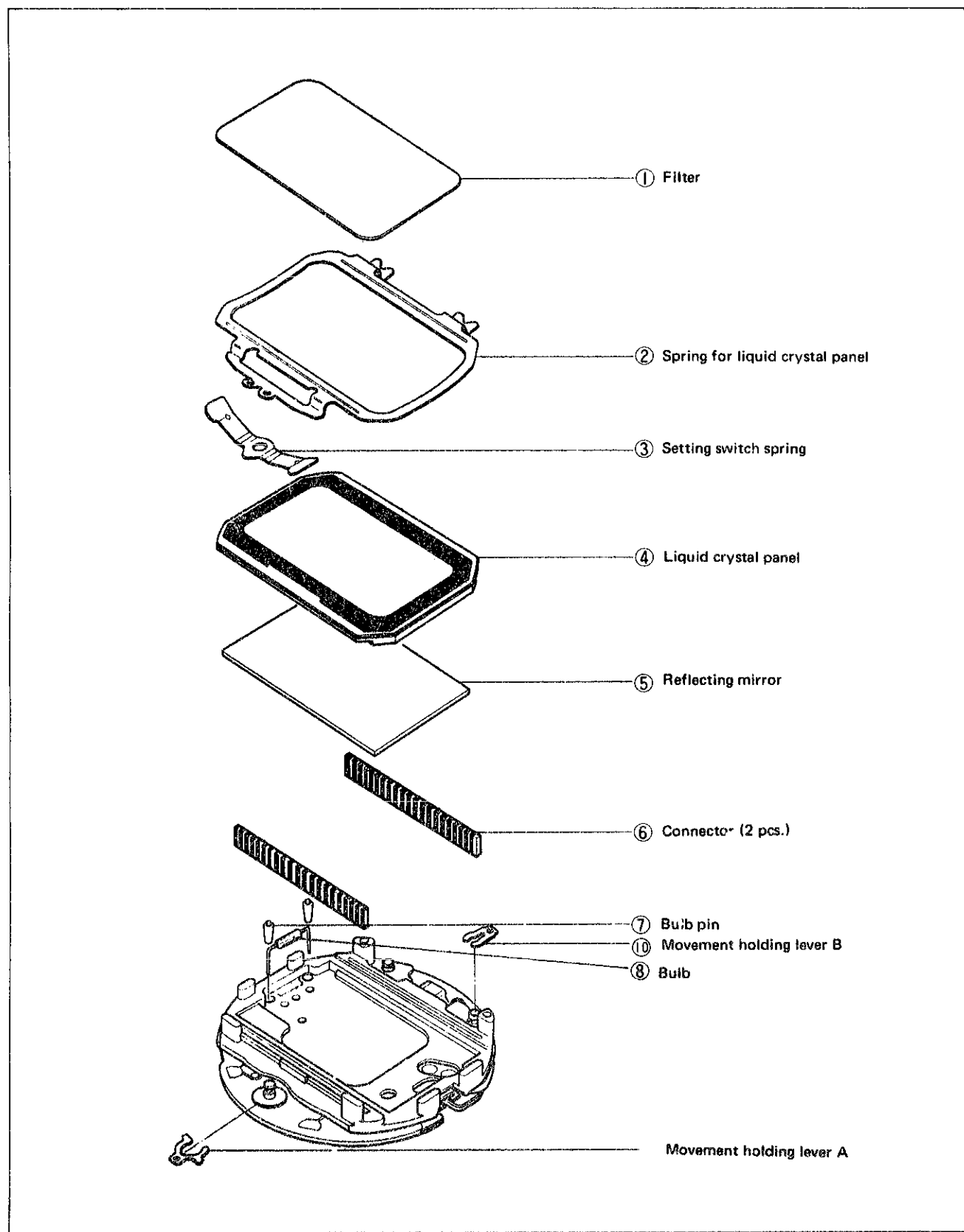

### Remarks for disassembling and reassembling

② **Spring for liquid crystal panel**  
 Insert the tips of the tweezers into the two holes of the spring for liquid crystal panel and pry it up in the arrow-marked direction for disassembling.

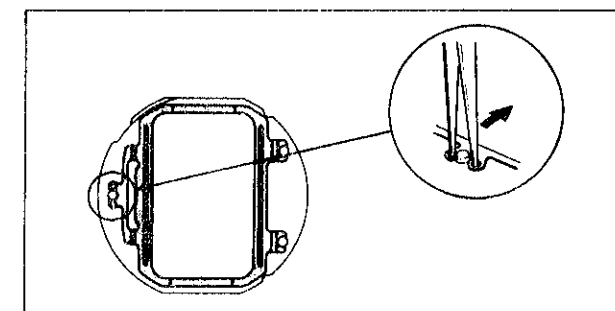

③ **Setting switch spring**  
 There are two different types of setting switch spring.

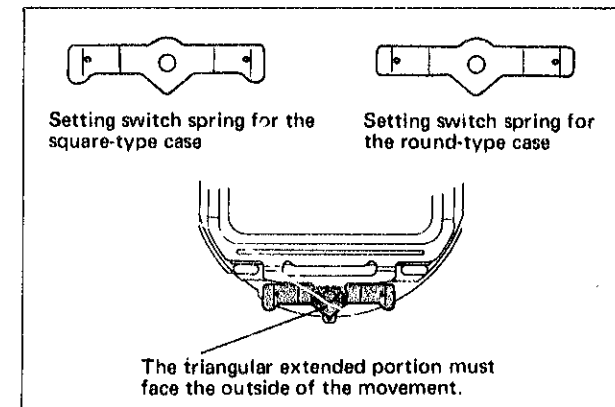

④ **Liquid crystal panel**  
 Use fingercots to disassemble and reassemble the liquid crystal panel.

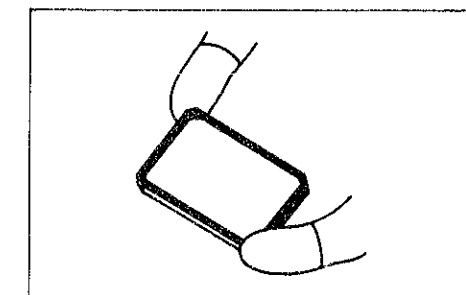

⑥ **Connector**  
 Although two connectors are used, there is no difference between the two. The black portions are conductive. Check to see if there are any scratches or contamination.

⑧ **Bulb**  
 Do not disassemble the bulb from the circuit block except when it is replaced with a new one.  
 When replacing the bulb, set it as shown in the illustration on the right.

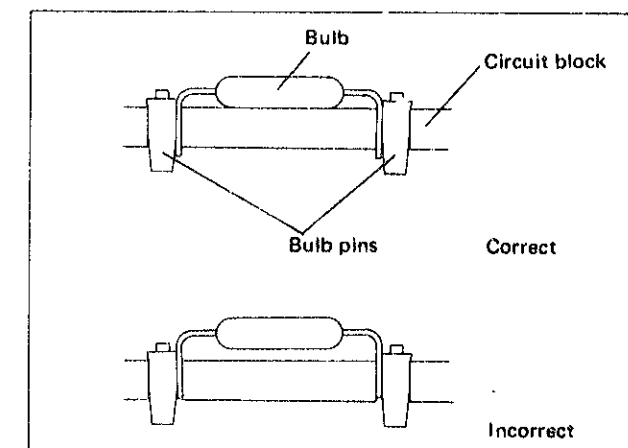

⑨ ⑩ **Movement holding levers "A" and "B"**  
 The movement holding levers "A" and "B" have different shapes. Be careful not to mistake "A" and "B" for each other.

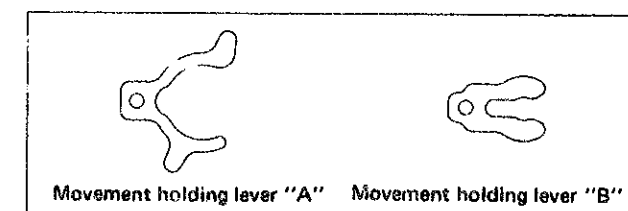

## 2. Switch mechanism side

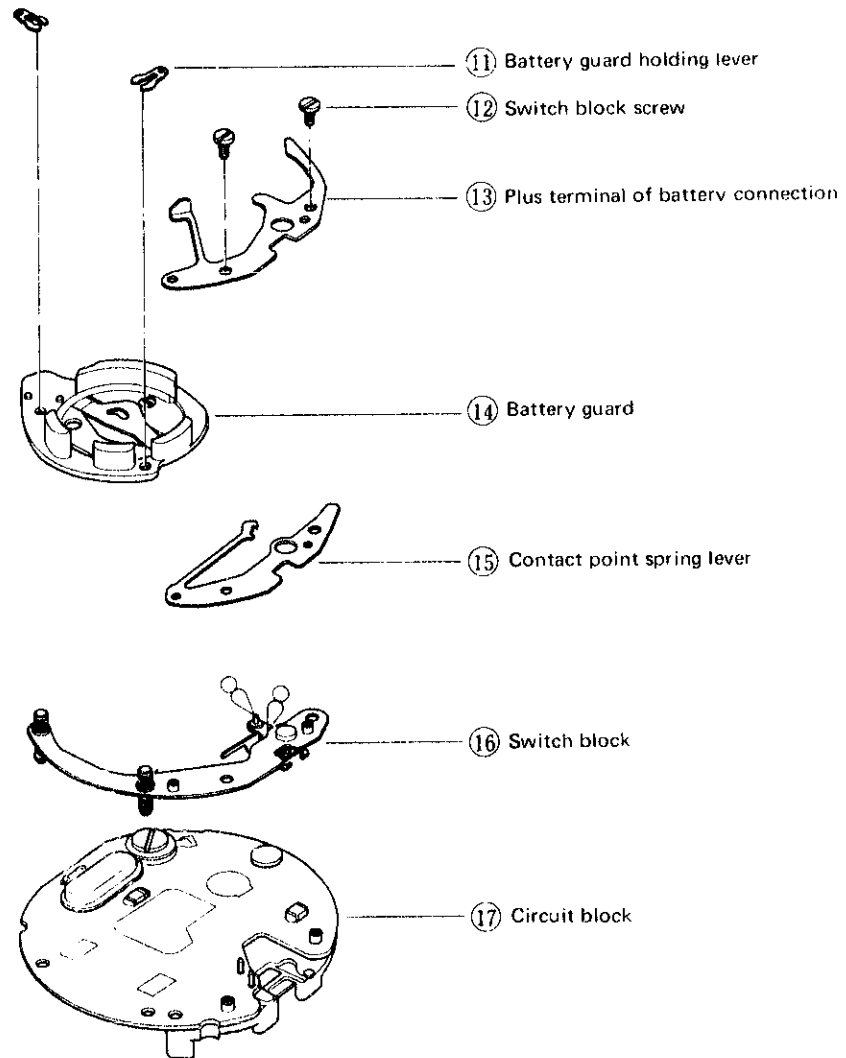

## Remarks for disassembling and reassembling

① **Battery guard holding lever**  
 The battery guard holding lever is the same as the movement holding lever "B". Move the battery guard holding lever in the arrow-marked directions for disassembling and reassembling.

④ **Switch block**  
 Reassemble the contact point spring of the switch block in between the two pins (the unlock switch pin and the display switch pin) of the circuit block.

### ● Function of the switch block (contact point spring)

The contact point spring touches neither the unlock switch pin nor the display switch pin.

The contact point spring touches the unlock switch pin and this makes it possible for the display to be adjusted. (When the time digits are being displayed, the second digits are ready to be adjusted.)

The contact point spring touches the display switch pin and this enables the changeover to and from the time display and the alarm display.

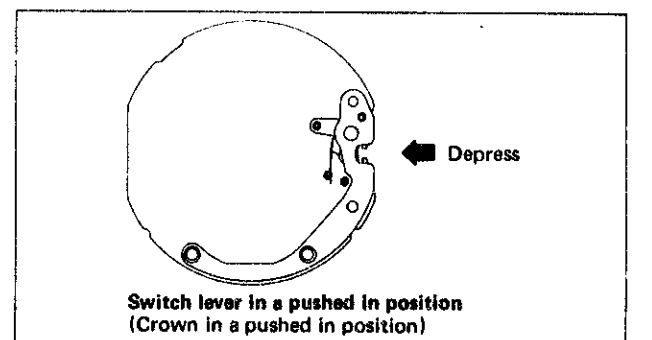
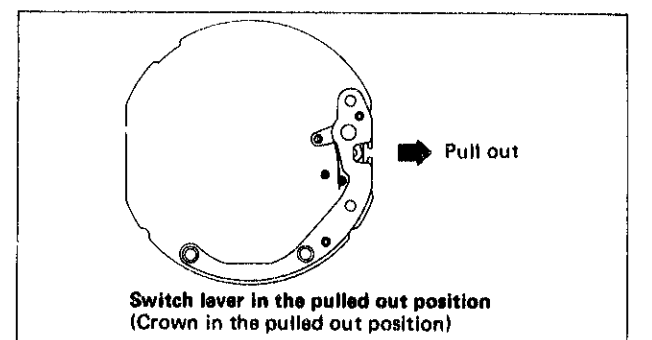
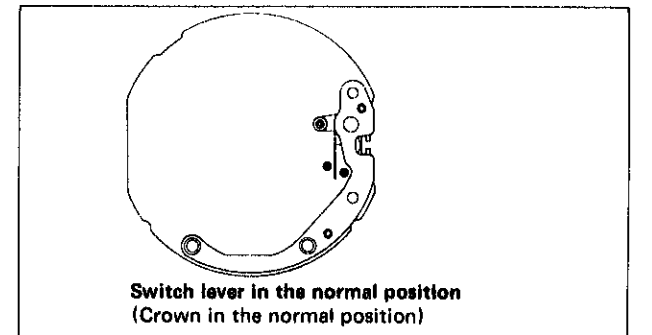
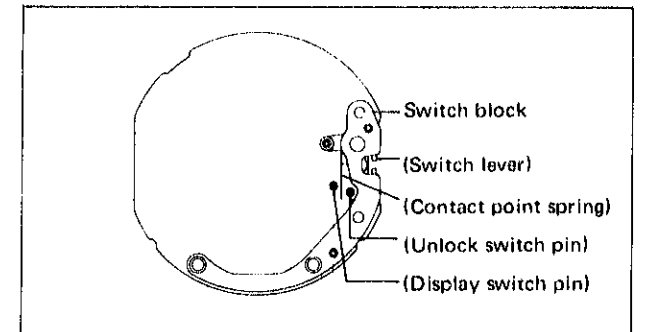
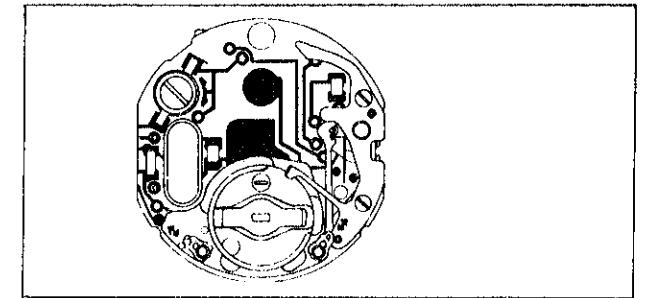



### 3. Cleaning

#### 1) HOW TO CLEAN

Name of parts	Cleaning	Drying	Solution	Remarks
Connector 	Rinse or clean with a soft brush.	Cool air	Alcohol	<ul style="list-style-type: none"> <li>• Clean the connected portion of the connector to the liquid crystal panel and the circuit block.</li> <li>• Do not use benzine or trichloroethylene as they expand the connector.</li> </ul>
Plastic parts	Rinse or clean with a soft brush.	Cool air	Benzine or alcohol	
Other parts (excluding the parts that must not be cleaned.)	Rinse or clean with a soft brush.	Cool or hot air	Benzine, trichloroethylene or alcohol	<ul style="list-style-type: none"> <li>• When cleaning the switch block, be careful not to bend the thin spring.</li> </ul>

#### 2) PARTS THAT MUST NOT BE CLEANED

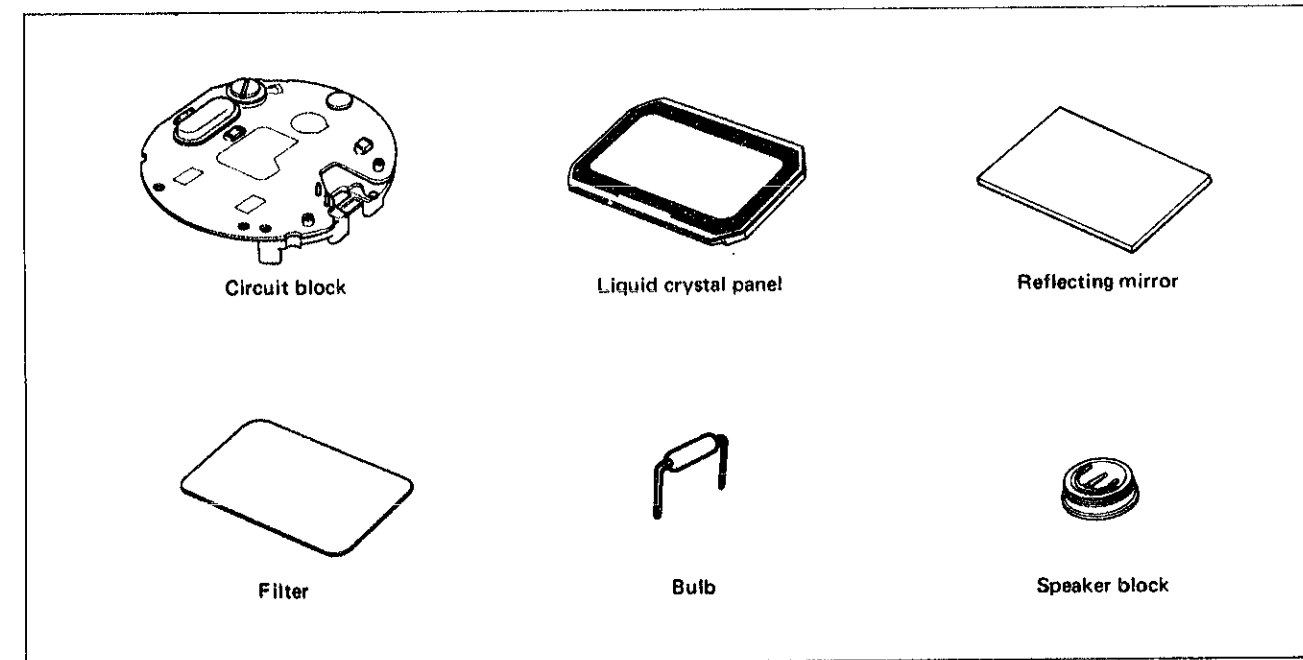

- Only the conductive portions should be wiped with a cloth moistened with benzine or alcohol and dried with cool air.
- Use a brush to clean dust and lint off.

# VIII. CHECKING AND ADJUSTMENT

## 1. Guide table for checking and adjustment

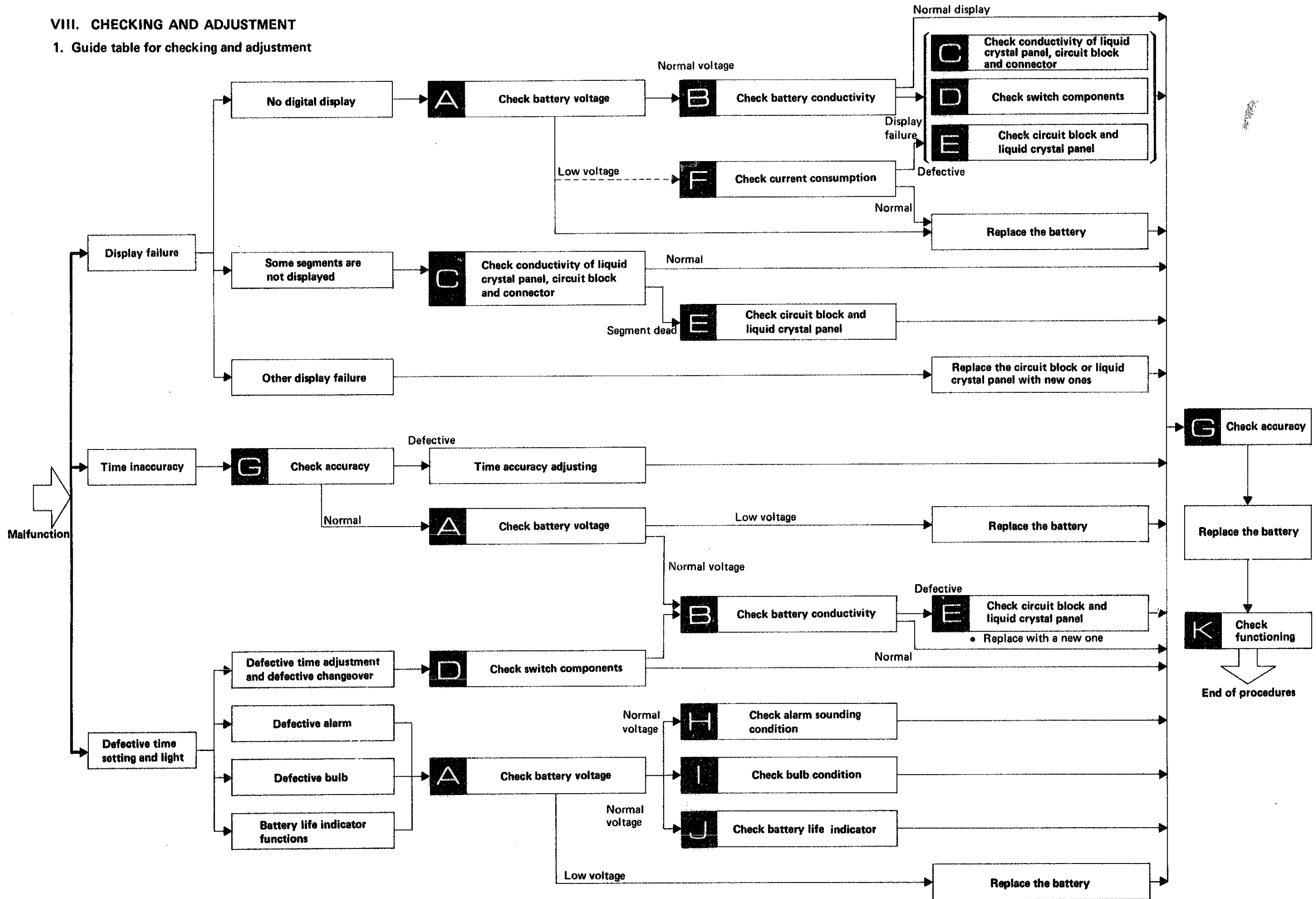



Note:

- If it is difficult to locate the malfunctioning

portion, proceed to **K** Check functioning first.

## 2. Malfunction and checking points

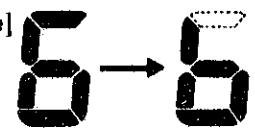
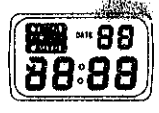

- Check in numerical order.
- Refer to "Procedures for checking and adjustment" on the following pages.

FAULTY SYMPTOMS		CHECKING POINTS								
		A	B	C		D	E	H	I	K
		Battery voltage	Battery conductivity	Liquid crystal panel	Circuit block	Connector	Switch components	Circuit block, Liquid crystal panel	Alarm sounding condition	Bulb condition
DISPLAY FAILURE	Stop (Though the digits are displayed, digital figures do not change).	①	②				③	④		
	No digital display, dim digital display or extremely slow response. [Example] 	①	②	③	⑤	④		⑥		
	Some segments of the digital figures are not lighted or dim. [Example] 			②	③	①				
	All segments are displayed or the segments which should be on and off are reversed as shown in the illustration. [Example]  			②	③	①				
	Some portions of the liquid crystal panel will make black dots or appear iridescent. [Example] 			①						
TIME INACCURACY	Gain or loss tested by the Quartz Tester.	①	②							
	Though Quartz Tester indicates the normal figures, a watch gains or loses when it is worn on the wrist.	①	②		③			④		
DEFECTIVE TIME SETTING OR LIGHT	Light is not lit or light is lit but dims soon.	①							②	
	Alarm does not sound.	①			③			②		
	Display adjustment is impossible, or the display is extinguished while it is being adjusted.						①	②		
	All digital figures are flashing.	①								②

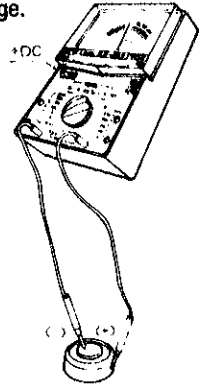
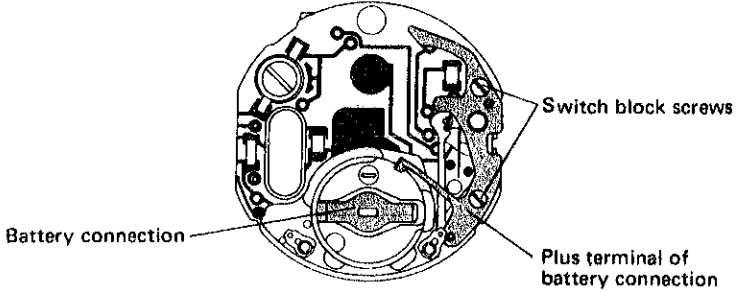

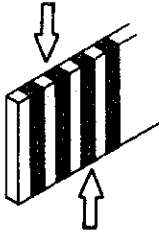
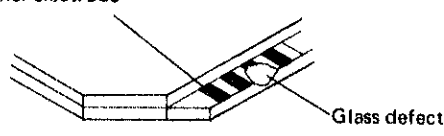
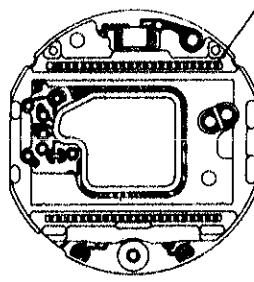
### 3. Procedures for checking and adjustment

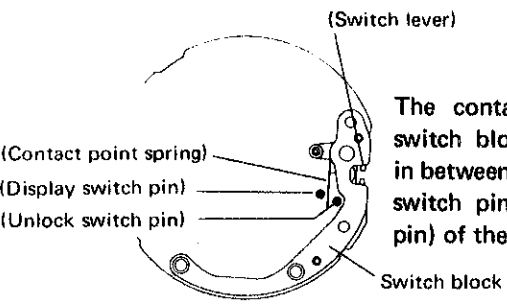
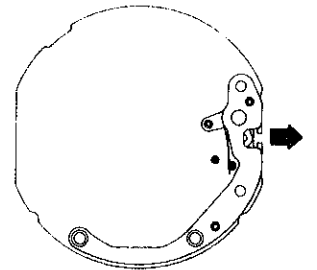
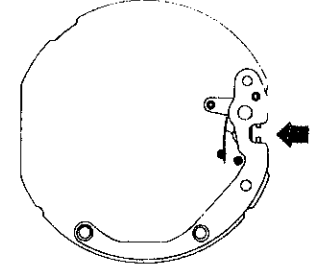
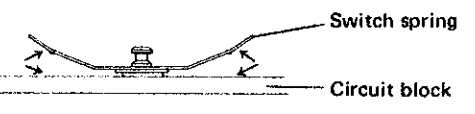

	Procedure	Result
<p style="writing-mode: vertical-rl; transform: rotate(180deg);"><b>△</b> CHECK BATTERY VOLTAGE</p>	<p>Use the following procedures to check battery voltage.</p> <ul style="list-style-type: none"> <li>• Set up the volt-ohm-meter               <ul style="list-style-type: none"> <li>Range to be used: DC 3 V</li> </ul> </li> <li>• Measuring               <ul style="list-style-type: none"> <li>Probe Red (+) . . . . Battery surface (+)</li> <li>Probe Black (-) . . . Battery surface (-)</li> </ul> </li> </ul> 	<p>More than 1.5 V → Normal            Less than 1.5 V → Defective            Replace battery with a new one.</p>
<p style="writing-mode: vertical-rl; transform: rotate(180deg);"><b>□</b> CHECK BATTERY CONDUCTIVITY</p>	<p><b>First check</b>            Check for any contamination on the battery, battery connection and plus terminal of battery connection.</p> <p><b>Second check</b>            Make sure that the switch block screws are tightened firmly.</p>  <p><b>Third check</b>            Check to see if there is battery electrolyte leakage.</p> <ul style="list-style-type: none"> <li>• How to repair battery electrolyte leakage               <ol style="list-style-type: none"> <li>1. Remove the movement from the case.</li> <li>2. Disassemble the movement.</li> <li>3. Clean the parts contaminated with battery electrolyte.                   <ul style="list-style-type: none"> <li>▪ Clean the circuit block.                       <ol style="list-style-type: none"> <li>(1) Wipe off battery electrolyte on the circuit block with a cloth moistened with distilled water (or normal water) first and then with a cloth moistened with alcohol.</li> </ol> <p><b>Note:</b></p> <ul style="list-style-type: none"> <li>○ Do not use such fluffy cloth as gauze, flannel, etc.</li> <li>○ Be careful that the trimmer condenser is not exposed to water or alcohol.</li> </ul> <ol style="list-style-type: none"> <li>(2) Dry with cool air by using a dryer.</li> </ol> </li> <li>▪ Clean the other parts.                       <ol style="list-style-type: none"> <li>(1) Wipe off battery electrolyte on the other parts with a soft brush moistened with distilled water (or normal water) first and then rinse them with alcohol.</li> <li>(2) Dry with cool air by using a dryer.</li> </ol> </li> </ul> </li> <li>4. Reassemble the movement                    Replace the battery with a new one.</li> <li>5. Check to see if the time setting function and the current consumption are normal.</li> </ol> </li> </ul>	<p>Uncontaminated → Normal            Contaminated → Defective            Wipe off any foreign matter.</p> <p>No loosened screws → Normal            Loosened screws → Defective            Retighten screws.</p> <p>No battery electrolyte leakage → Normal            Battery electrolyte leakage → Defective            Wipe off battery electrolyte by following the repairing procedures.</p>

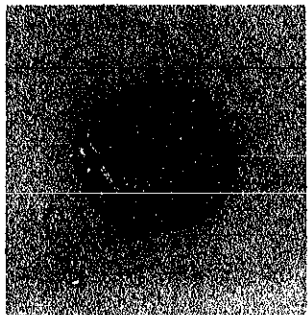
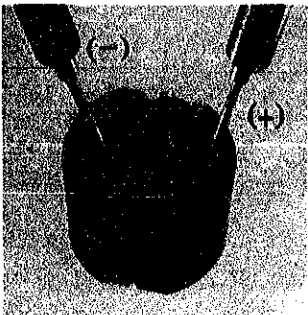
Procedure	Result
<p><b>First check</b> Check for any contamination, crack and tiny break of the connector.</p> <p>Check carefully the connecting portions of the liquid crystal panel and the circuit block.</p> 	<p>No contamination, crack or tiny break → Normal</p> <p>Contaminated → Defective Wipe off any foreign matter.</p> <p>Crack or tiny break → Defective Replace the connector with a new one.</p>
<p><b>Second check</b> Check the liquid crystal panel electrode (connecting portion of the connector for any foreign matter and glass defects.)</p> <p>Liquid crystal panel electrode</p> 	<p>Uncontaminated or no glass defect → Normal</p> <p>Contaminated → Defective Wipe off any foreign matter.</p> <p>Glass defect → Defective Replace the liquid crystal panel with a new one.</p>
<p><b>Third check</b> Check the circuit block electrode (connecting portion of the connector) for any contamination.</p> <p>Circuit block electrode</p> 	<p>Uncontaminated → Normal</p> <p>Contaminated → Defective Wipe off any foreign matter.</p>

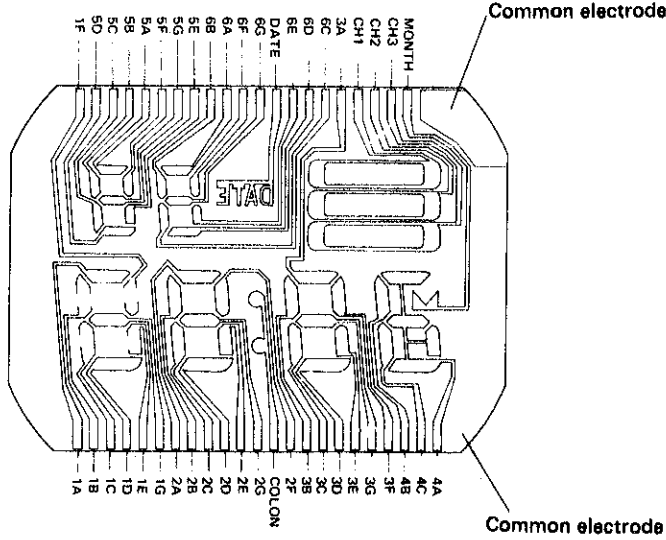
Procedure	Result
<p><b>First check</b></p> <ul style="list-style-type: none"> <li>Check for any contamination on the contact point spring of the switch block, the unlock switch pin of the circuit block and the display switch pin.</li> <li>Check to see if the contact point spring of the switch block functions correctly.</li> </ul> <p><b>SWITCH LEVER IN THE NORMAL POSITION</b></p>  <p>The contact point spring of the switch block should be positioned in between the two pins (the unlock switch pin and the display switch pin) of the circuit block.</p> <p><b>SWITCH LEVER IN THE PULLED OUT POSITION</b></p>  <p>The contact point spring of the switch block touches the unlock switch pin of the circuit block, and the display is ready to be adjusted.</p> <p><b>SWITCH LEVER IN THE PUSHED IN POSITION</b></p>  <p>The contact point spring of the switch block touches the display switch pin of the circuit block, and the changeover to and from the time display and the alarm time display.</p> <p><b>Second check</b> Check for any contamination on the contact portions of the switch spring and the circuit block.</p> 	<p>Uncontaminated → Normal</p> <p>Contaminated → Defective Wipe off any foreign matter.</p> <p>Functions as shown in the illustration on the left → Normal</p> <p>Does not function as shown in the illustration on the left → Defective</p> <ul style="list-style-type: none"> <li>The contact point spring is bent → Defective Correct by using tweezers.</li> <li>The contact point spring is out of place → Defective Reassemble it in the correct position.</li> </ul>  <p>Incorrect</p> <ul style="list-style-type: none"> <li>The contact point spring is broken → Defective Replace the switch block with a new one.</li> </ul> <p>Uncontaminated → Normal</p> <p>Contaminated → Defective Wipe off any foreign matter.</p>

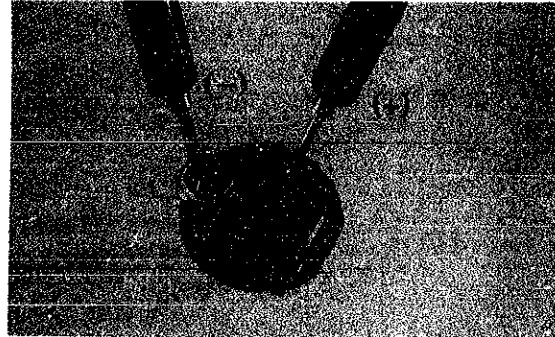
	Procedure	Result
	<p><b>First check</b> Check to see if the electric signal flows into the liquid crystal panel from the circuit block correctly.</p> <ol style="list-style-type: none"> <li>Set the battery in the movement and hold by the battery holding spring.</li> <li>Disassemble the spring for liquid crystal panel, filter and liquid crystal panel by following the disassembling procedures.</li> <li>Set up the volt-ohm-meter Range to be used: DC 3 V</li> <li>Measuring Probe Red (+) . . . Pin on the circuit block (+) (Shown in the photo.)  Probe Black (-) . . . (Apply to several portions.)</li> </ol> <div style="display: flex; justify-content: space-around; margin-top: 10px;">   </div> <p><b>Note:</b> Touch the connector lightly with the probes.</p>	<p>More than 0.8 V → Normal Less than 0.8 V → Defective Replace the circuit block with a new one.</p> <p>(The above voltage is obtained when measured by the volt-ohm-meter AF-105 or S-831. If the other volt-ohm-meter is used, the voltage obtained might be less than the above.)</p>

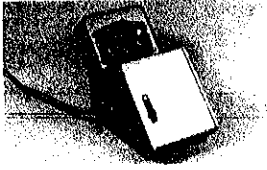
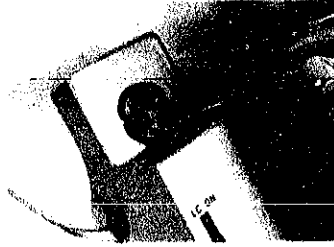
	Procedure	Result
	<p><b>Second check</b> Check the liquid crystal panel for broken panel pattern, short-circuit or other defects.</p> <ol style="list-style-type: none"> <li>Set up the volt-ohm-meter. Range to be used: OHMS R X 1 (Any range will do if 3 V is applied to the terminal of the volt-ohm-meter.)</li> <li>Disassemble the liquid crystal panel from the movement and turn the liquid crystal panel upside down.</li> <li>Measuring Apply red and black probes of volt-ohm-meter to the common electrode of the liquid crystal panel (Either red or black probe can be applied.) and the other probe to the segment electrode.</li> </ol> <div style="text-align: center; margin-top: 10px;">  </div>	<p>Lights up → Normal Does not light up → Defective Replace the liquid crystal panel with a new one.</p>
	<p><b>Check to see if the current consumption is normal.</b></p> <ol style="list-style-type: none"> <li>Set up the volt-ohm-meter. Range to be used: DC 0.03 mA (by using AF-105) DC 12 μA (by using S-831).</li> <li>Place the battery on the plus terminal of battery connection with its (-) surface up.</li> <li>Measuring Probe Red (+) . . . Battery connection Probe Black (-) . . . Battery surface (-)</li> </ol> <div style="text-align: center; margin-top: 10px;">  </div>	<p>Less than 2.5 μA → Normal More than 2.5 μA → Defective Proceed to <b>B</b>, <b>C</b> and <b>D</b></p>

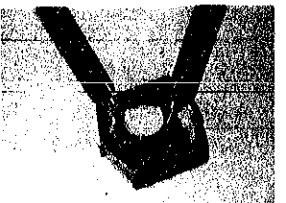
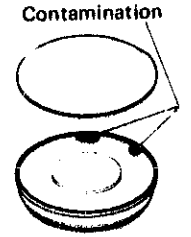
	Procedure	Result
CHECK ACCURACY	<p><b>G</b></p> <p>Check gain and loss of time. Set up the Quartz Tester. When the Quartz Tester QT-77 is used.</p> <p>(1) Set the microphone switch (Electro-magnetic and Electric-field detection Changeover-Power switch) to LC ON position. (2) Push the watch selection button (LC Button).</p>  <ul style="list-style-type: none"> <li>How to adjust time accuracy. The watch will gain or lose according to the direction in which the trimmer condenser is turned. Adjustment should therefore be made after ascertaining with the Quartz Tester whether the watch tends to gain or lose.</li> </ul> <p><i>Note for handling the trimmer condenser</i> Avoid excessive depressing and turning of the trimmer condenser.</p> 	<p>No gain and loss → Normal Gain and loss → Defective Proceed to Time accuracy adjusting</p>
CHECK ALARM SOUNDING CONDITION	<ul style="list-style-type: none"> <li>When the alarm does not sound.</li> </ul> <p><b>First check</b> Check the lead terminal of the speaker block and the lead pattern of the circuit block for any contamination and also check to see if the lead terminal of the speaker block is bent.</p>  <p><b>Second check</b> Measure the resistance of the coil in the speaker block and check for any broken coil wire or short-circuit of the speaker block.</p> <p>(1) Set up the volt-ohm-meter Range to be used: OHMS R X 1 (2) Measuring Apply red and black probes of the volt-ohm-meter to the speaker frame and the lead terminal of the speaker block. (Either red or black probe will do.)</p>  <ul style="list-style-type: none"> <li>When the alarm sound is not clear.</li> </ul> <p><b>Third check</b> Remove the sound diaphragm and check the speaker block for any contamination and also check if the sound diaphragm is bent. (See "Remarks for disassembling and reassembling" for the disassembling procedures of the sound diaphragm.)</p> 	<p>Uncontaminated → Normal Contaminated → Defective Wipe off any foreign matter. Bent → Defective Correct by using tweezers.</p> <p>70 Ω ~ 90 Ω → Normal Less than 70 Ω (short-circuit) → Defective More than 90 Ω (broken coil wire) → Defective Replace the speaker block with a new one.</p> <p>Uncontaminated and not bent → Normal Contaminated → Defective Wipe off any foreign matter. Bent → Defective Replace the sound diaphragm with a new one.</p>

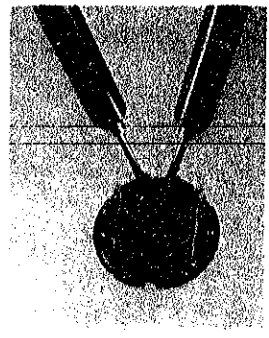
	Procedure	Result
CHECK BULB CONDITION	<p>Check to see if there is a broken filament in the bulb.</p> <p>(1) Set up the volt-ohm-meter. Range to be used: OHMS R X 1 (2) Measuring Apply red and black probes of the volt-ohm-meter to the two terminals of the bulb. (Either red or black probe can be applied.)</p> 	<p>Lights up → Normal Does not light up → Defective Replace the bulb with a new one.</p>
CHECK BATTERY LIFE INDICATOR	<p>Check to see if the battery life indicator functions correctly.</p> <p><b>First check</b></p> <p>(1) Set up the Micro Test. Set the voltage at 1.1 V. (2) Apply the probe of the Micro Test to the watch. Clip Red (+) . . . . Changeover switch button (crown) or case back Probe Black (-) . . . Battery connection (3) Set the time digits before 9:02:00. (4) Check to see if the battery life indicator functions correctly (entire display starts flashing) when the time digits pass the 9:03:00.</p> <p><b>Second check</b></p> <p>(1) Set up the Micro Test. Set the voltage at 1.5 V. (2) Check by following the procedures from (2) through (4) in the First check.</p>	<p>Flashes → Normal Does not flash → Defective Replace the circuit block with a new one.</p> <p>Does not flash → Normal Flashes → Defective Replace the circuit block with a new one.</p>

Procedure

K

Check to see if the changeover and the adjustment of the display can be made correctly by button operation.

**First check**

Check to see if the changeover to and from the time display, TIMER display, ALARM display and AUTOMATIC ALARM display can be made correctly by depressing crown (changeover switch button).



**Second check**

With crown in the pulled out position, check to see if each display is selected and set by depressing buttons "A" and "B". Be sure that there is no dead segment.

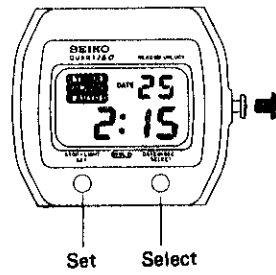

**Third check**

With crown in the normal position, check to see if the light is lit by depressing button "B" in.

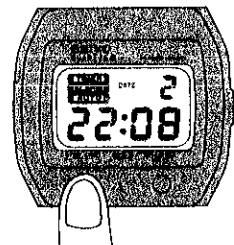

**Fourth check**

Check to see if the alarm starts sounding when buttons "A" and "B" are depressed at the same time.

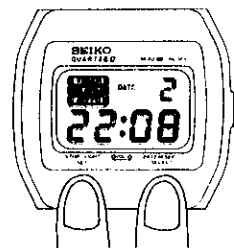

**Fifth check**

Check to see if the alarm sounds at the required time in TIMER display, ALARM display and AUTOMATIC ALARM display.

All procedures of Disassembling, Reassembling, Checking and Adjustment are completed.

CHECK FUNCTIONING