

SEIKO

DIGITAL QUARTZ

Cal. D031A

PARTS LIST

Cal. D031A

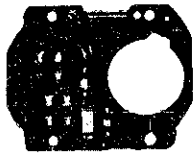
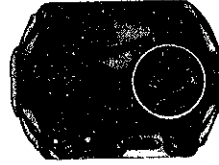
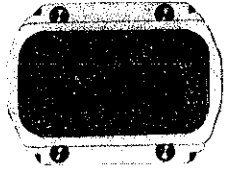

4001 328

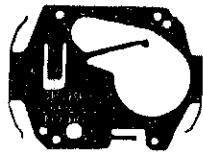

4245 324



4270 327



4313 192

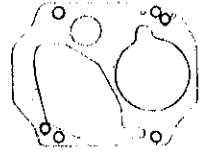

4398 111



4398 113

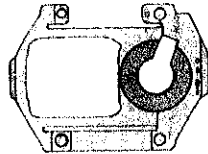

4398 114



4446 140



4510 481



4521 197



4530 231



☆ SEIKO TR926W



012 458



017 247

2/1

Cal. D031A

Characteristics

Casing diameter : 19.0 mm × 25.6 mm
 Maximum height : 3.9 mm without battery
 Frequency of quartz crystal oscillator : 32,768 Hz (Hz=Hertz Cycles per second)
 Time display : Digital Display System showing hour (12-hour or 24-hour indication), minute and second.
 ("A"(A.M.)/"P"(P.M.) is displayed only when the hour digit is being adjusted.)
 Calendar display : Digital Display System showing day and date. (Month is displayed only when the calendar is adjusted.)
 One disired language can be selected among five languages (English, Spanish, French, German and Italian)
 to indicate the day of the week.
 Dot matrix sweep display system : The time display and the calendar display start sweeping from right to left every hour on
 the hour.
 Display medium : Nematic Liquid Crystal, FE-Mode.
 Regulation system : Trimmer condenser
 Illuminating light : Illuminates the display in the dark
 Battery life indicator : All the digits in the display begin flashing.

| PART NO. | PART NAME | PART NO. | PART NAME |
|----------------|------------------------------|----------|-----------|
| 4001 328 | Circuit block | | |
| 4245 324 | Switch spring | | |
| 4270 327 | Battery connection (—) | | |
| 4313 192 | Connector | | |
| 4398 111 | Battery guard | | |
| 4398 113 | Liquid crystal panel frame | | |
| 4398 114 | Conductive connector frame | | |
| 4446 140 | Crystal unit cushion | | |
| 4510 481 | Liquid crystal panel | | |
| 4521 197 | Reflecting mirror | | |
| 4530 231 | Bulb | | |
| 012 458 | Switch spring screw | | |
| 017 247 | Tube for switch spring screw | | |
| ☆SEIKO TR926W | Silver (II) oxide battery | | |
| ☆Maxell SR926W | Silver oxide battery | | |
| ☆U.C.C. 399 | | | |

Remarks :

Battery

☆SEIKO TR926W }
 ☆Maxell SR926W } The substitutive battery might be added to the applied battery in the future.
 ☆U.C.C. 399 } In that case, please refer to separate "BATTERY LIST FOR SEIKO
QUARTZ WATCHES".
 Note that SEIKO battery is marked with "SEIZAIKEN" on its (+) side.

☆⇨ Please see remarks.

Part numbers in light letters are not shown in photos.

TECHNICAL GUIDE

SEIKO DIGITAL QUARTZ

CAL. D031A

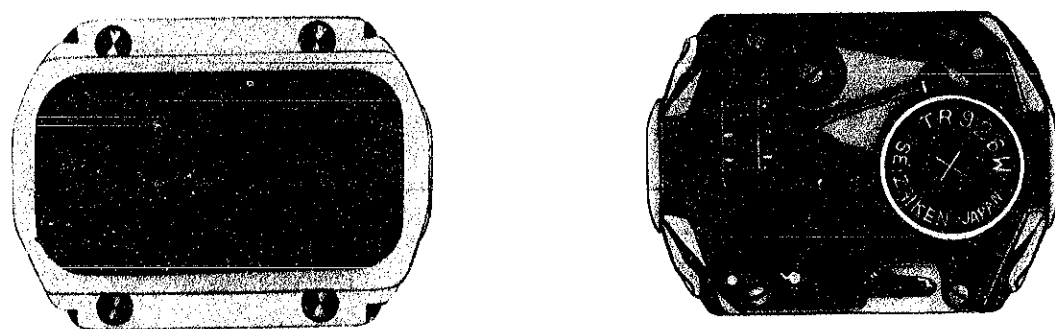

CONTENTS

| | |
|---|---|
| I. SPECIFICATIONS | 1 |
| II. STRUCTURE OF THE CIRCUIT BLOCK | 1 |
| III. DISPLAY FUNCTION | 2 |
| IV. DISASSEMBLING AND REASSEMBLING | 3 |
| V. CHECKING AND ADJUSTMENT | 5 |
| • Check battery voltage | 5 |
| • Check battery conductivity | 5 |
| • Check all dots display and liquid crystal panel | 5 |
| • Check conductivity of liquid crystal panel, circuit block and connector | 5 |
| • Check circuit block | 6 |
| • Check current consumption | 7 |
| • Check conductivity of switch components | 7 |
| • Check accuracy | 8 |
| • Check functioning and adjustment | 8 |

I. SPECIFICATIONS

| Cal. No. | D031A |
|---------------------------------|---|
| Item | |
| Display medium | Nematic Liquid Crystal, FEM (Field Effect Mode) |
| Liquid crystal driving system | Multiplex driving system |
| Display system | <ul style="list-style-type: none"> • Dot matrix display system • Time display: Hour, minute and second (12 or 24 hour indication) • Calendar display: Day and date |
| Additional mechanism | <ul style="list-style-type: none"> • Dot matrix sweep display system • Sweep display test system • Illuminating light • Battery life indicator |
| Loss/gain | Loss/gain at normal temperature range Monthly rate : less than 15 seconds (Annual rate : less than 3 minutes) |
| Outside diameter | $\phi 26.0\text{mm}$ (19.0mm between 6 o'clock and 12 o'clock sides) (25.6mm between 3 o'clock and 9 o'clock sides) |
| Height | 3.9mm |
| Regulation system | Trimmer condenser |
| Measuring gate by Quartz Tester | Any gate is available. (Measure the daily rate with all dots displayed) |
| Battery | SEIKO (SEIZAIKEN) TR926W, Maxell SR926W or U.C.C. 399. Battery life is approximately 2 years. Voltage: 1.55V |

II. STRUCTURE OF THE CIRCUIT BLOCK

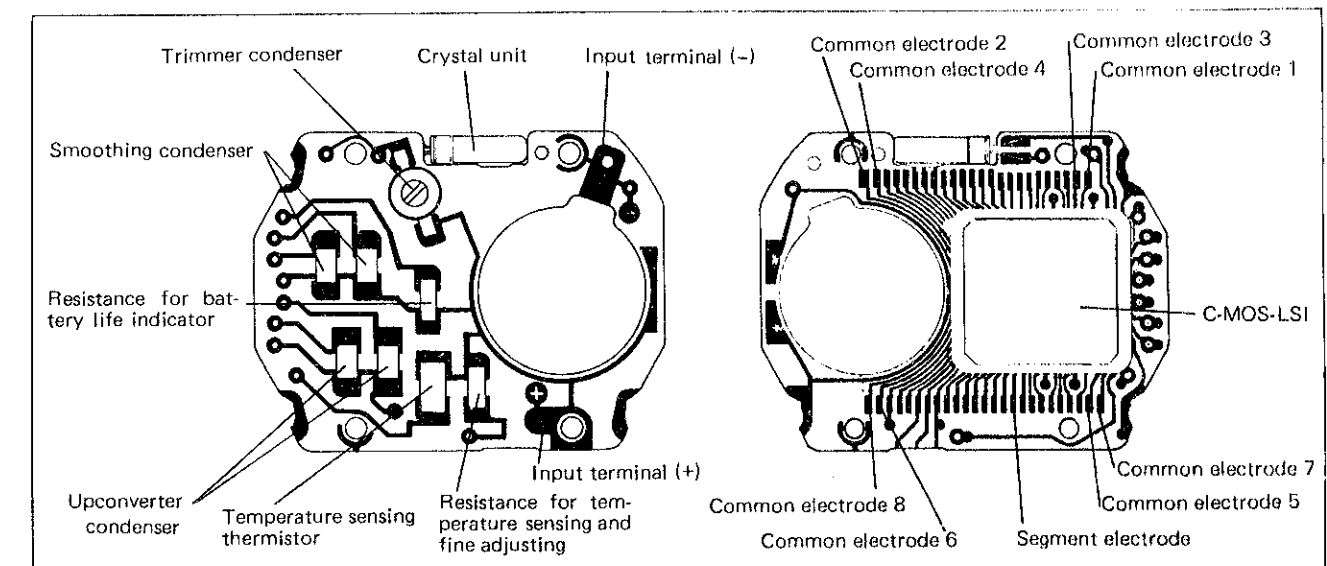

III. DISPLAY FUNCTION

- Cal. D031A uses the "Dot matrix display system" in which digits, letters and marks are displayed by the arrangement of small dots. It is equipped with the "Sweep display system" which enables the time display and calendar display to start sweeping from right to left every hour on the hour and when button B is depressed.

• Time and calendar display

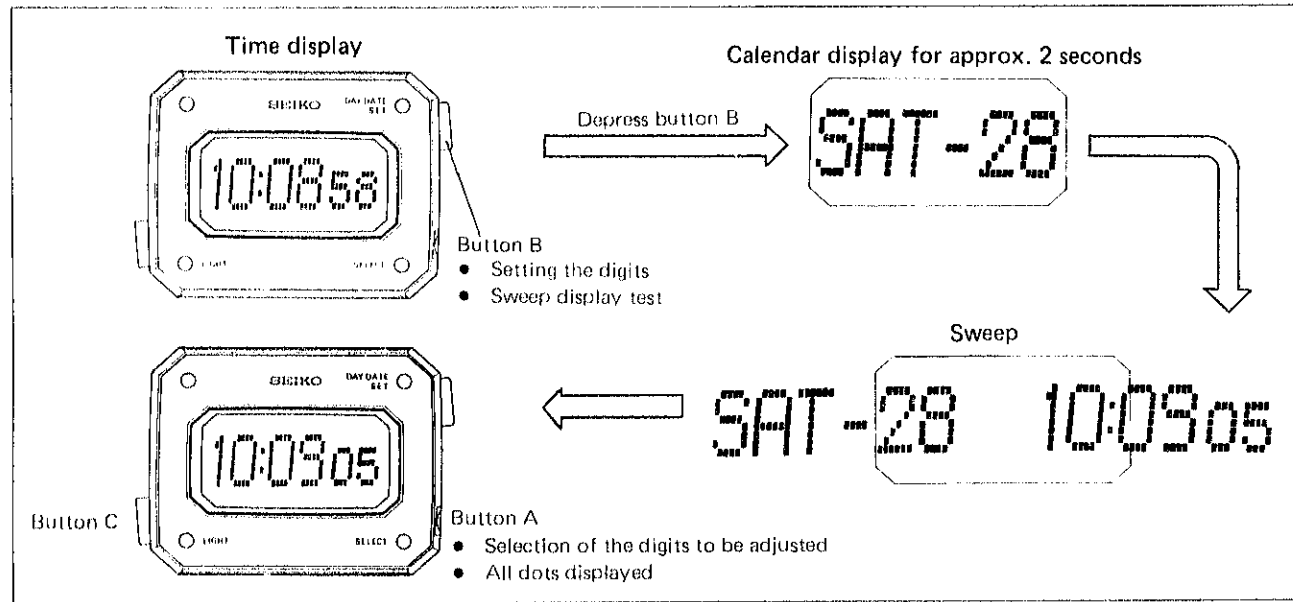

• Sweep display test

If button B is depressed for more than 2 seconds from the time display, the sweep is repeated continuously as Time display → Calendar display → Time display. Depress button A, B or C to return to the time display.

• All dots displayed

Depress button A for more than 2 seconds and all the dots are displayed. This is designed to facilitate checking accuracy. Depress button A, B or C to return to the time display.

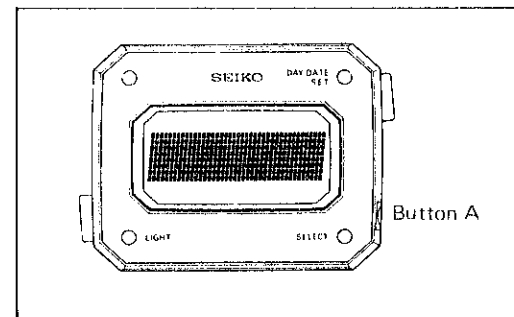

• Selection of the language to indicate the day of the week

- From the time display depress button A six times, and the language initial and the day of the week are displayed with the language initial flashing.
- The language initial changes in the following order by each depression of button B and the language to indicate the day of the week also changes automatically.

EN (English) → ES (Spanish) → FR (French)
 1.....IT (Italian) ← DE (German) ←

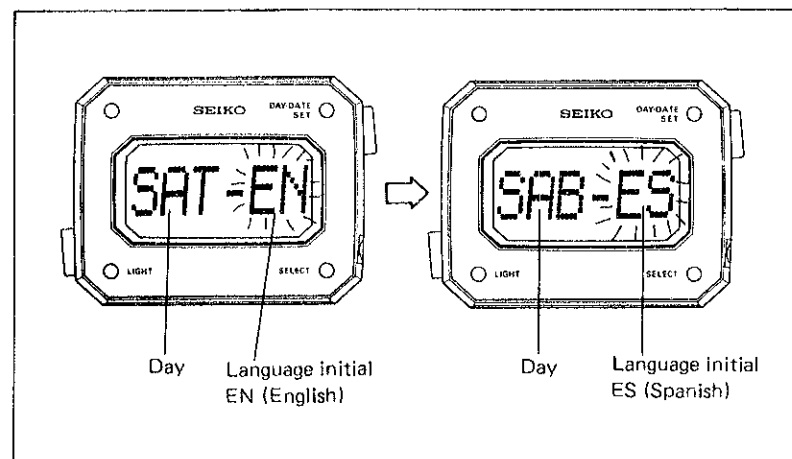

IV. DISASSEMBLING AND REASSEMBLING

1. Disassembling and reassembling of the case

Ex.) Case No. D031-4000 R0

This model uses decorative pins (4 pcs.) on the glass.

• How to set the glass

Adhere the glass with decorative pins to the case bezel by the adhesive for glass S-310. Also apply the S-310 on the bottom (4 places) of the decorative pins.

Note: Apply the S-310 slightly to the surface to be adhered so that it is uniformly coated.

• Adhering time

When left at the normal temperature (24°C) 24 hours
 When left at the temperature of 40°C ~ 50°C 5 to 6 hours

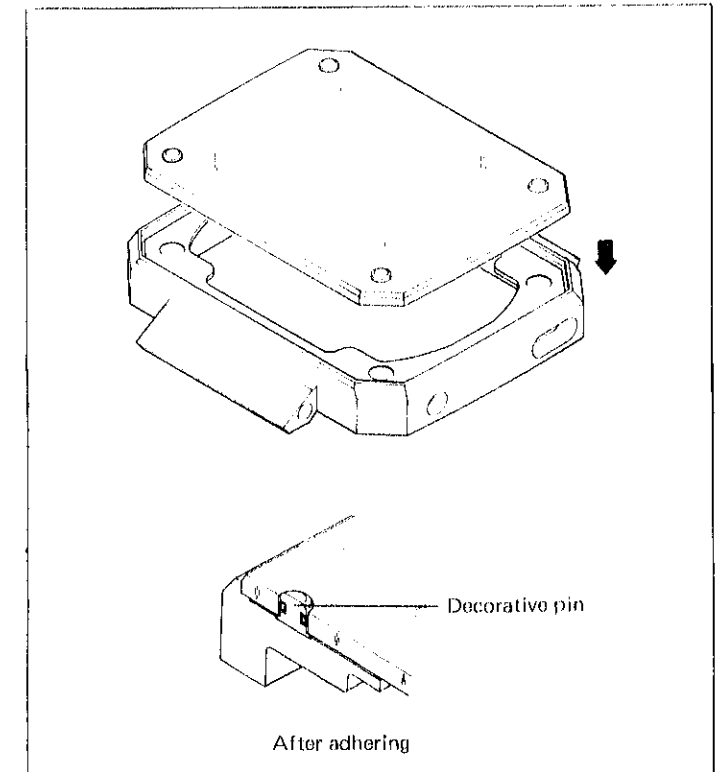

Note: The glass is supplied with the decorative pin with gasket. (The decorative pin and the gasket for decorative pin can be supplied separately as well.)

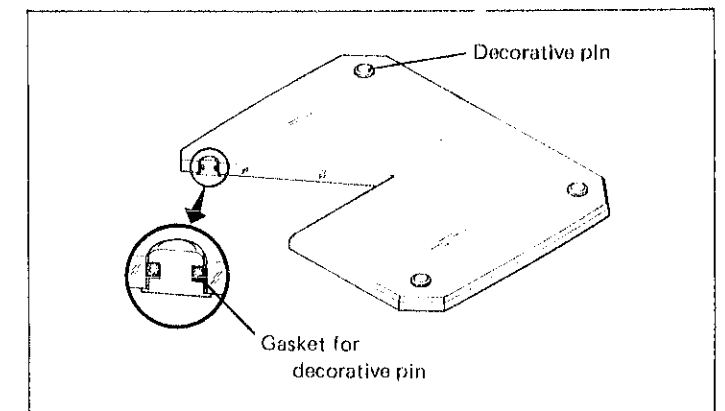

2. Disassembling and reassembling of the module

Disassembling Procedures Figs.: ① → ⑪
 Reassembling Procedures Figs.: ⑪ → ①

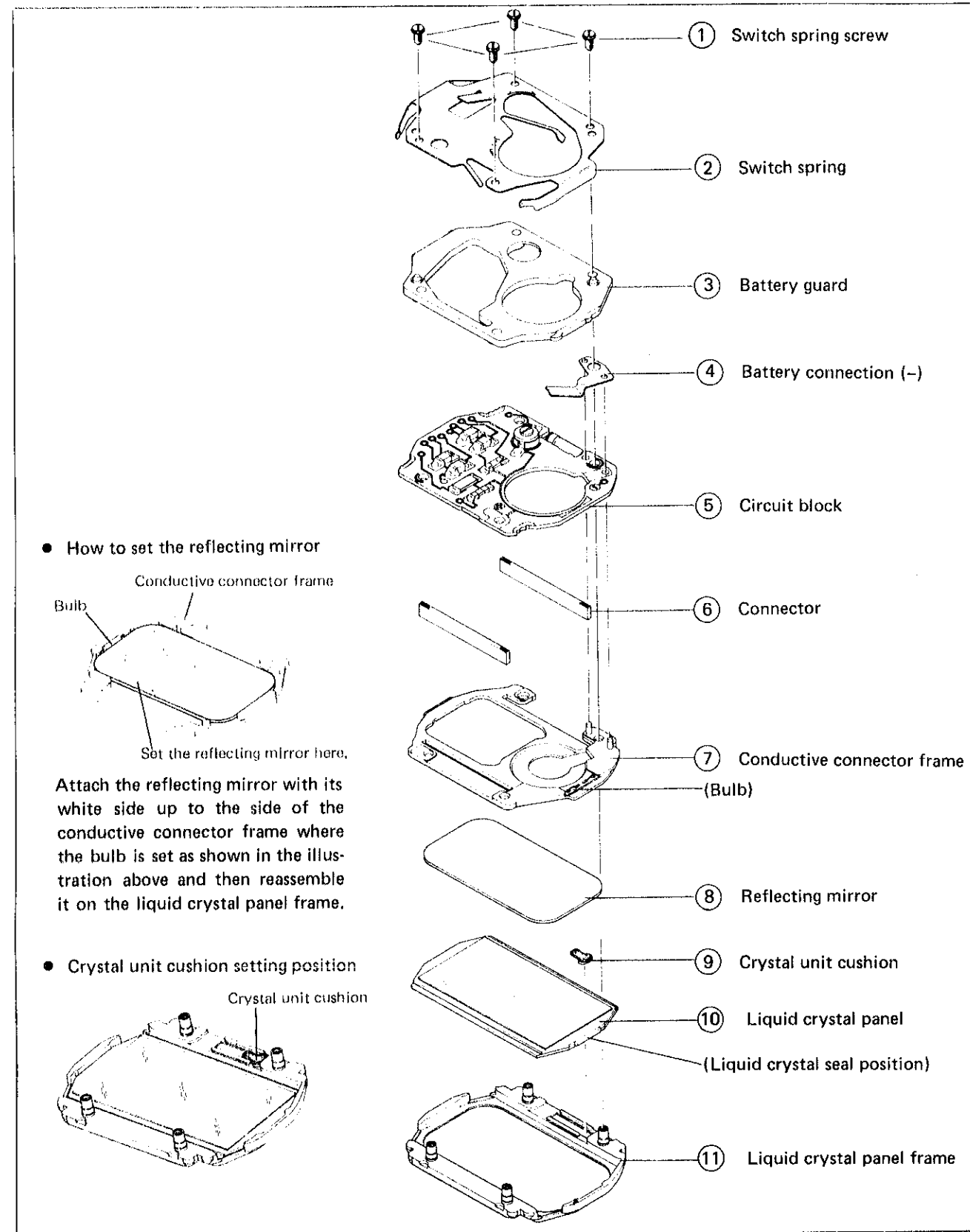

V. CHECKING AND ADJUSTMENT

● Refer to the "SEIKO QUARTZ TECHNICAL GUIDE, GENERAL INSTRUCTION" for Digital Watches for details.

| Procedure | |
|--|--|
| CHECK BATTERY VOLTAGE | <p>Result: More than 1.5V: Normal Less than 1.5V: Defective Replace the battery with a new one.</p> |
| CHECK BATTERY CONDUCTIVITY | |
| CHECK ALL DOTS DISPLAY AND LIQUID CRYSTAL PANEL | |
| <p style="text-align: center;">All dots displayed</p> | <ul style="list-style-type: none"> ● Depress button A for more than 2 seconds and all the dots light up. <p>Result: All the dots light up: Normal Lines of dots are not displayed partially crosswise or lengthwise: Defective</p> <ul style="list-style-type: none"> ● Check the common electrode of the liquid crystal panel at 8 places. ● Check the connector and the circuit block electrode for dust, lint, and contamination. |
| <p>(Ex.)</p> <p>The figure indicates poor conductivity in a part of the common electrode.</p> <p>The figure indicates poor conductivity of an electrode other than the common electrode.</p> | |
| CHECK CONDUCTIVITY OF LIQUID CRYSTAL PANEL, CIRCUIT BLOCK AND CONNECTOR | |
| <ul style="list-style-type: none"> ● Liquid crystal panel electrode <p>Common electrode 3 Common electrode 4 Common electrode 2 Common electrode 1 Common electrode 7 Common electrode 5 Common electrode 8 Common electrode 6</p> | <ul style="list-style-type: none"> ● In Cal. D031A, there are 8 common electrodes on the liquid crystal panel as shown in the illustration on the left and the number of electrodes used are more than those of other calibres. Therefore its conductivity may be affected easily both by the dust, lint, and contamination on the connecting portions between the common electrode and the connector, and their set position. Check the liquid crystal panel, circuit block, and connector. |

Procedure

CHECK CIRCUIT BLOCK

(1) Check the output voltage of the circuit block.

Range to be used: DC 3V

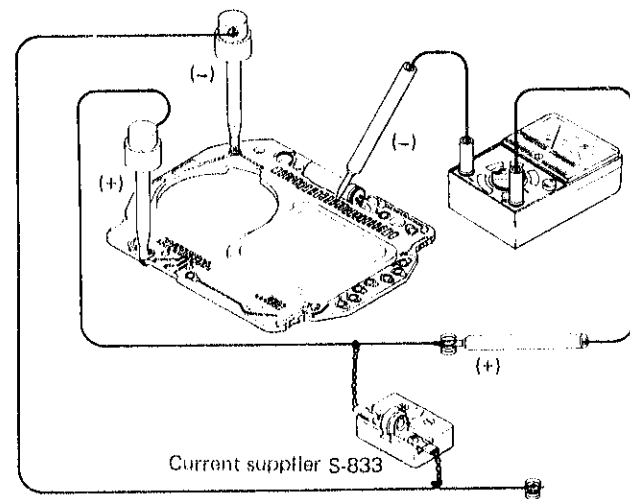

Result:
 More than 0.8V: Normal
 Less than 0.8V: Defective
 Replace the circuit block with a new one.

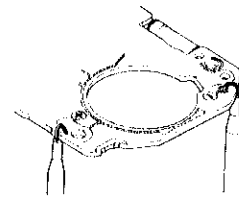

(2) Check the upconverter voltage of the circuit block.

Range to be used: DC 3V

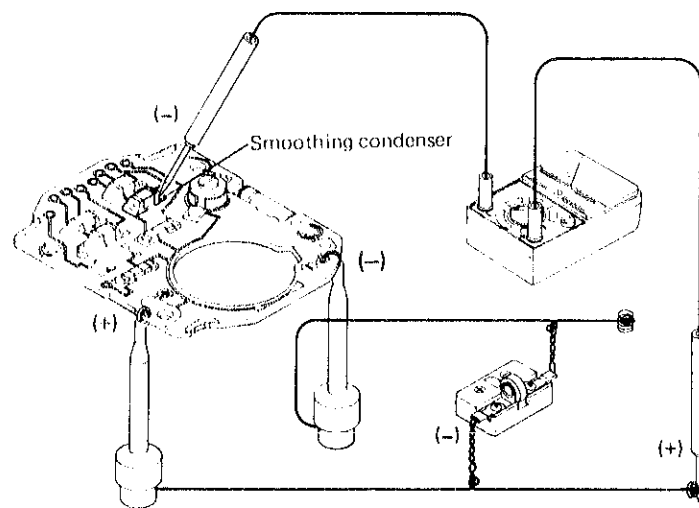

Result:
 More than 2.5V: Normal
 Less than 2.5V: Defective
 Replace the circuit block with a new one.

Procedure

CHECK CURRENT CONSUMPTION

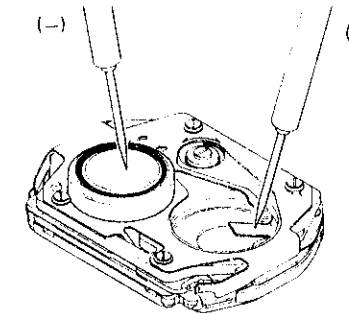

* How to check if the liquid crystal panel or the circuit block is defective when the current consumption is more than 3.4μA.

Result:
 Less than 3.4μA: Normal
 More than 3.4μA: Defective

- Check the current consumption for the circuit block alone.

Result:
 Less than 2.5μA:
 Replace the liquid crystal panel with a new one.
 More than 2.5μA:
 Replace the circuit block with a new one.

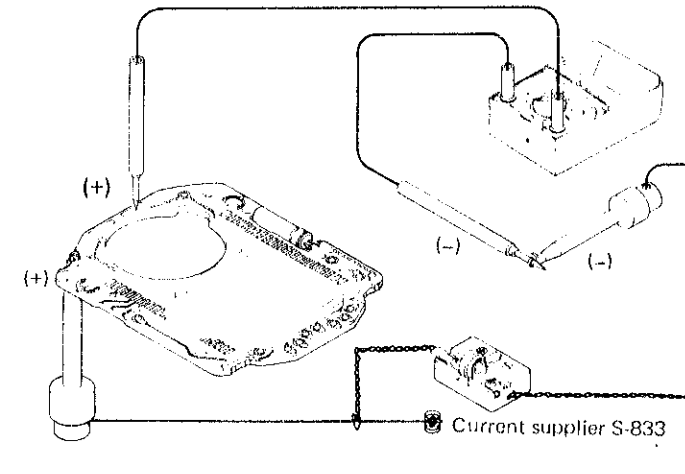

CHECK CONDUCTIVITY OF SWITCH COMPONENTS

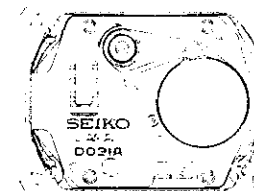

- Check to see if the switch spring (arrow-marked in the illustration on the left) touches the switch terminals of the circuit block when they are pushed in with the tips of tweezers and to see if they do not touch the switch terminals of the circuit block when released.
- Check the connecting portions for dust, lint, and other contaminations.

Result:
 Functions correctly: Normal
 Does not function correctly: Defective
 (If it is not adjustable, replace the switch spring with a new one.)

Procedure

CHECK ACCURACY

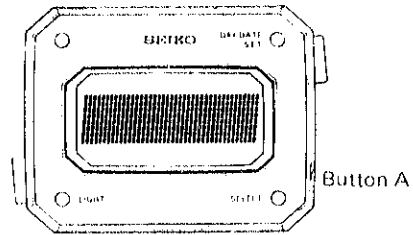

All dots displayed

- Depress button A for more than 2 seconds to light up all the dots and check the daily rate.
- Depress button A, B or C to return to the time display.

CHECK FUNCTIONING AND ADJUSTMENT

- Check to see if each display is activated correctly by depressing each button in accordance with the instruction on page 2.

All procedures of Disassembling, Reassembling, Checking and Adjustment are completed.